

Let's Shine.

800.737.2800 • fax 417.862.1232 • BoydAluminum.com

©2016 Boyd Aluminum Manufacturing. The Boyd sunburst and logotype are trademarks of Boyd Aluminum Manufacturing. All rights reserved. Due to continued product research, specifications are subject to change without notice.

910S-E1

040116

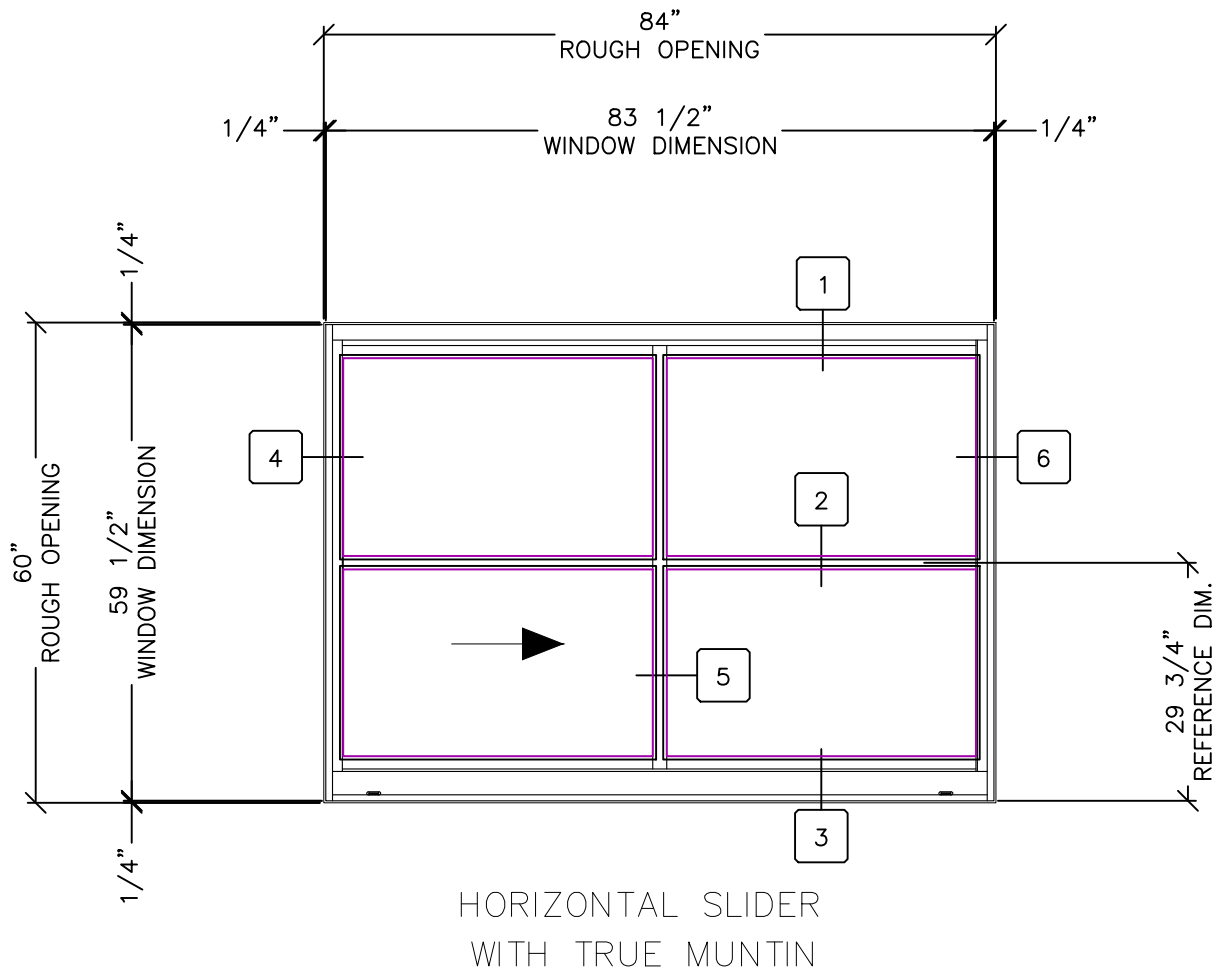

Let's Shine.

800.737.2800 • fax 417.862.1232 • BoydAluminum.com

©2016 Boyd Aluminum Manufacturing. The Boyd sunburst and logotype are trademarks of Boyd Aluminum Manufacturing. All rights reserved. Due to continued product research, specifications are subject to change without notice.

910S-E2

040116

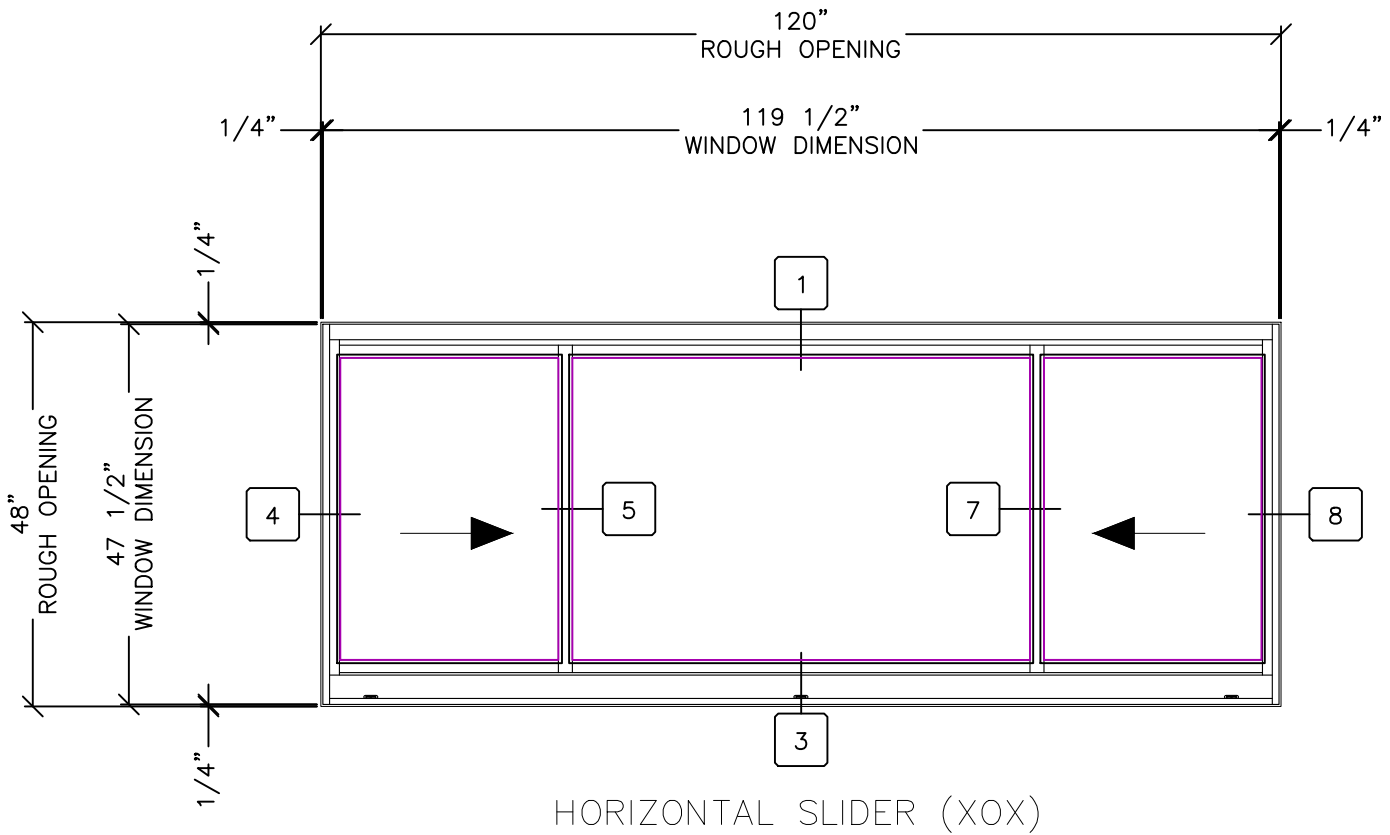

Let's Shine.

800.737.2800 • fax 417.862.1232 • BoydAluminum.com

©2016 Boyd Aluminum Manufacturing. The Boyd sunburst and logotype are trademarks of Boyd Aluminum Manufacturing. All rights reserved. Due to continued product research, specifications are subject to change without notice.

910S-E3

040116

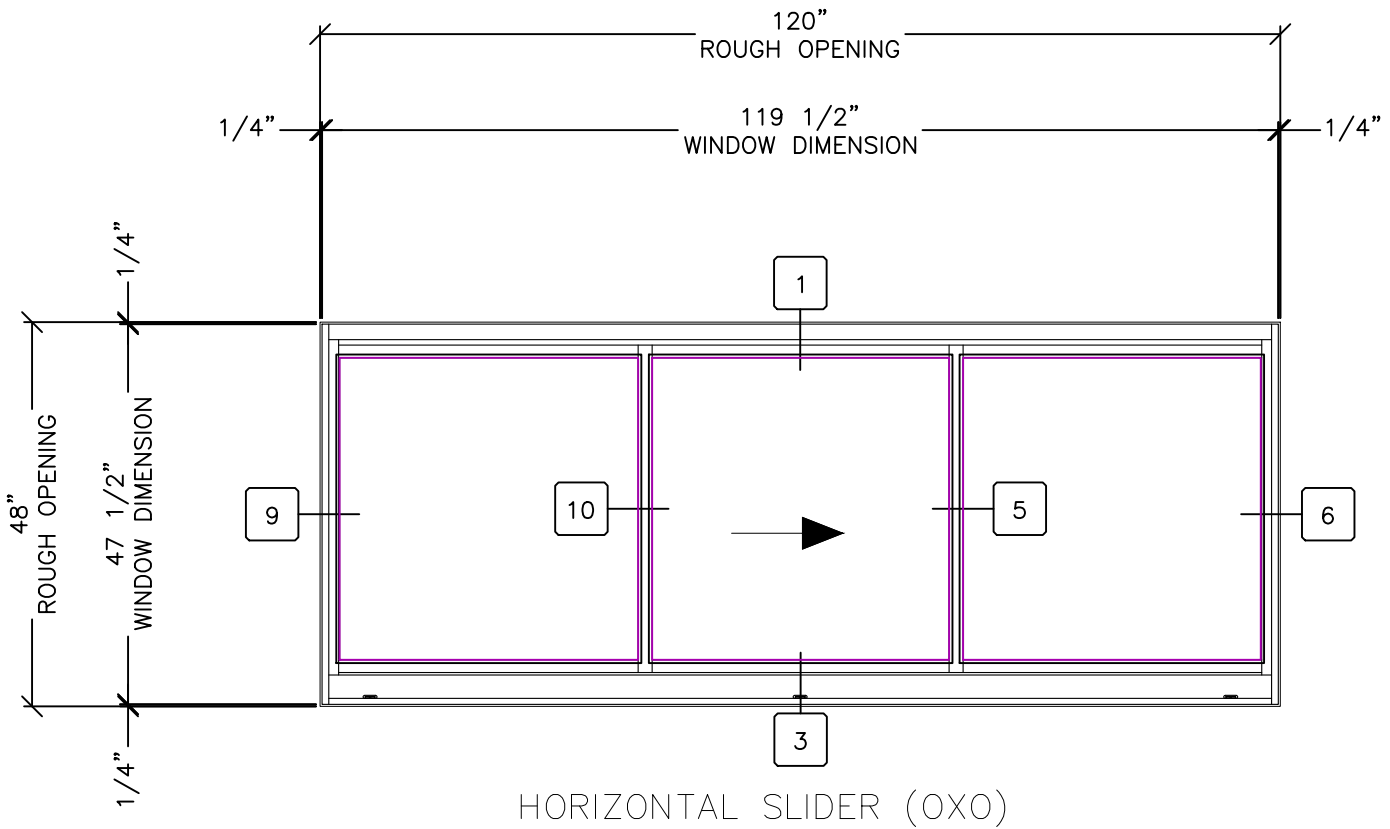

Let's Shine.

800.737.2800 • fax 417.862.1232 • BoydAluminum.com

©2016 Boyd Aluminum Manufacturing. The Boyd sunburst and logotype are trademarks of Boyd Aluminum Manufacturing. All rights reserved. Due to continued product research, specifications are subject to change without notice.

910S-E4

040116

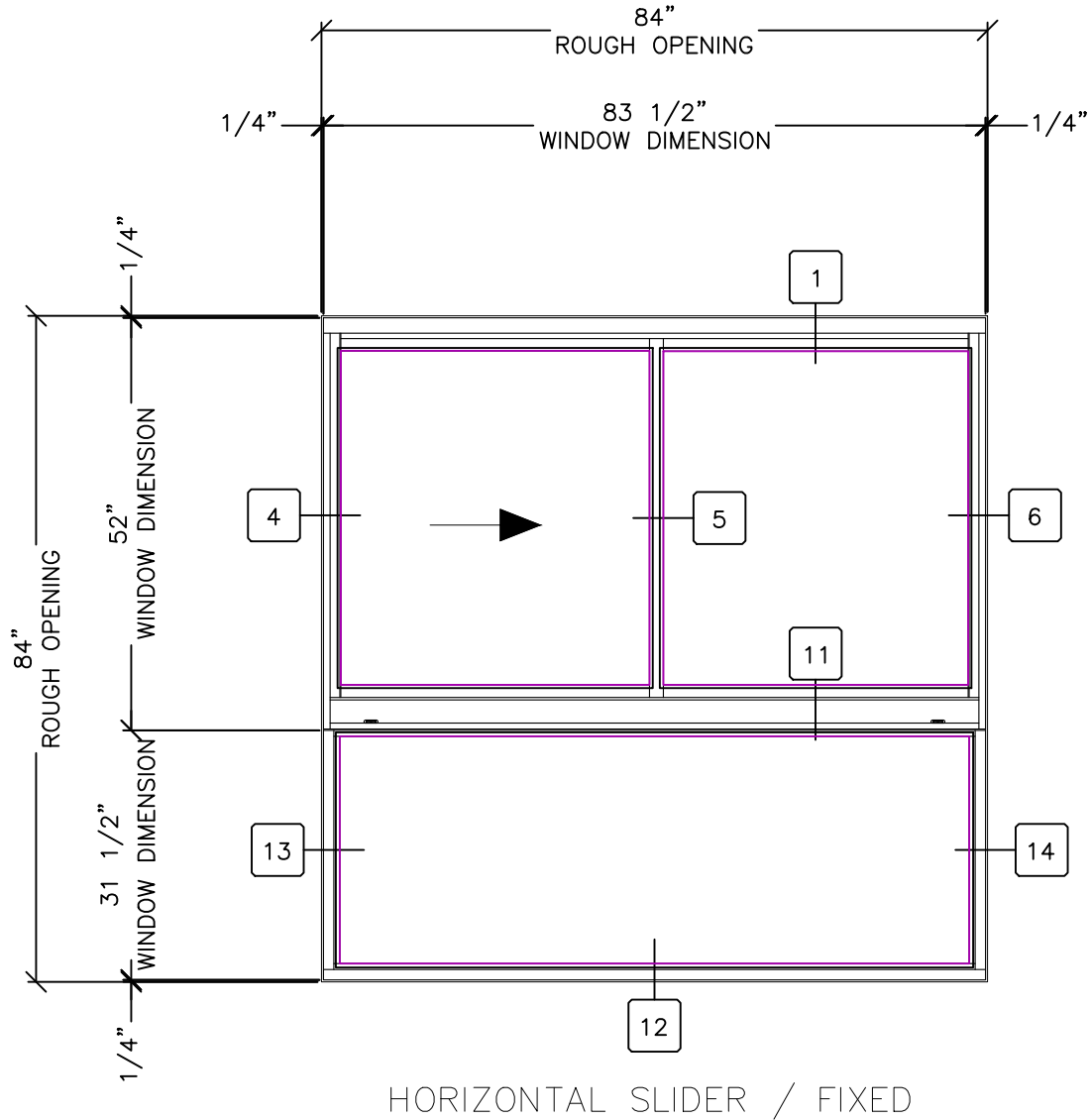

Let's Shine.

800.737.2800 • fax 417.862.1232 • BoydAluminum.com

©2016 Boyd Aluminum Manufacturing. The Boyd sunburst and logotype are trademarks of Boyd Aluminum Manufacturing. All rights reserved. Due to continued product research, specifications are subject to change without notice.

E5
040116

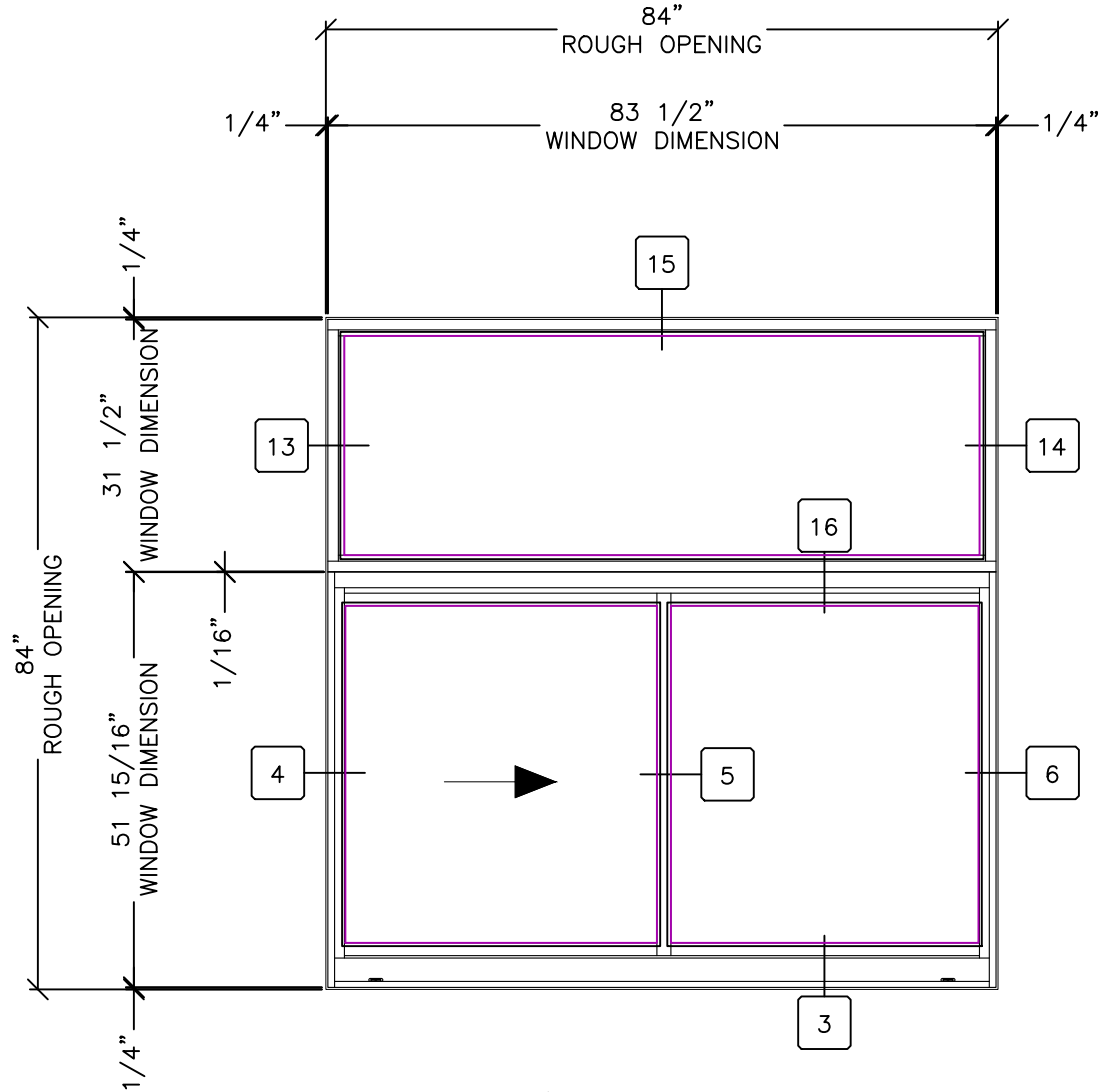

FIXED / HORIZONTAL SLIDER

Let's Shine.

800.737.2800 • fax 417.862.1232 • BoydAluminum.com

©2016 Boyd Aluminum Manufacturing. The Boyd sunburst and logotype are trademarks of Boyd Aluminum Manufacturing. All rights reserved. Due to continued product research, specifications are subject to change without notice.

910S-E6

040116

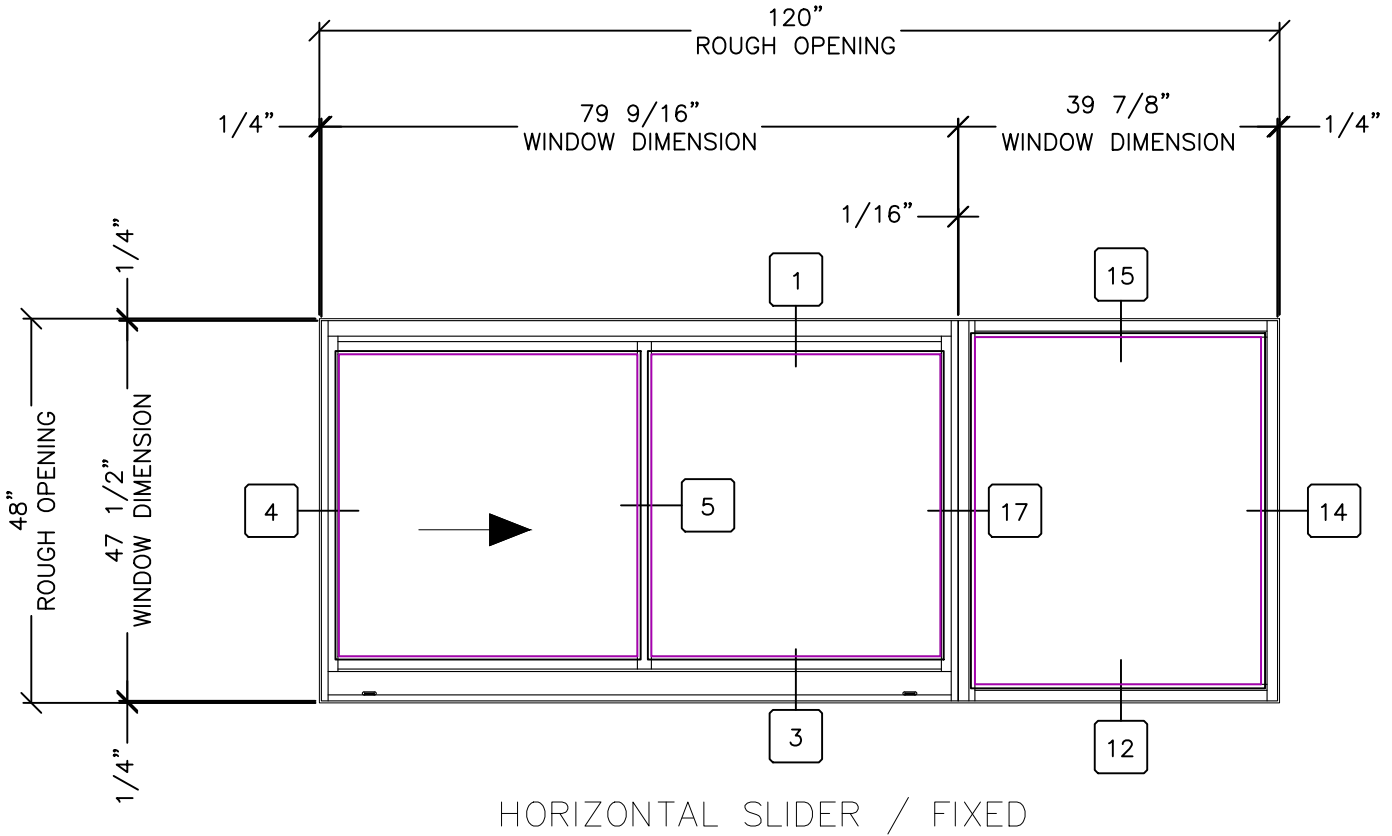

Let's Shine.

800.737.2800 • fax 417.862.1232 • BoydAluminum.com

©2016 Boyd Aluminum Manufacturing. The Boyd sunburst and logotype are trademarks of Boyd Aluminum Manufacturing. All rights reserved. Due to continued product research, specifications are subject to change without notice.

910S-E7

040116

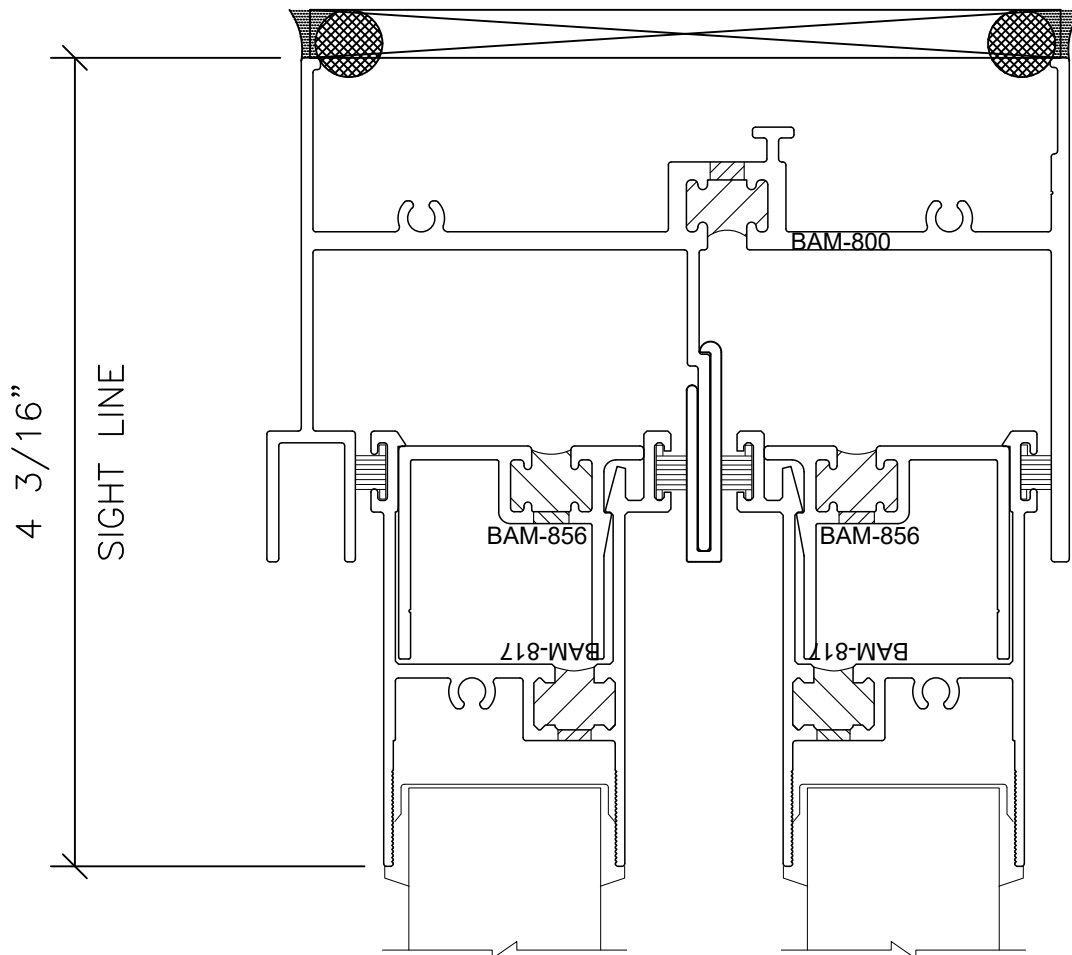

Let's Shine.

800.737.2800 • fax 417.862.1232 • BoydAluminum.com

©2016 Boyd Aluminum Manufacturing. The Boyd sunburst and logotype are trademarks of Boyd Aluminum Manufacturing.
All rights reserved. Due to continued product research, specifications are subject to change without notice.

910S-D1

040116

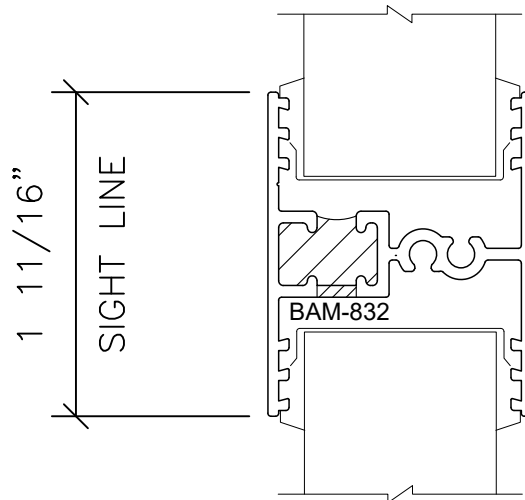

Let's Shine.

800.737.2800 • fax 417.862.1232 • BoydAluminum.com

©2016 Boyd Aluminum Manufacturing. The Boyd sunburst and logotype are trademarks of Boyd Aluminum Manufacturing.
All rights reserved. Due to continued product research, specifications are subject to change without notice.

910S-D2

040116

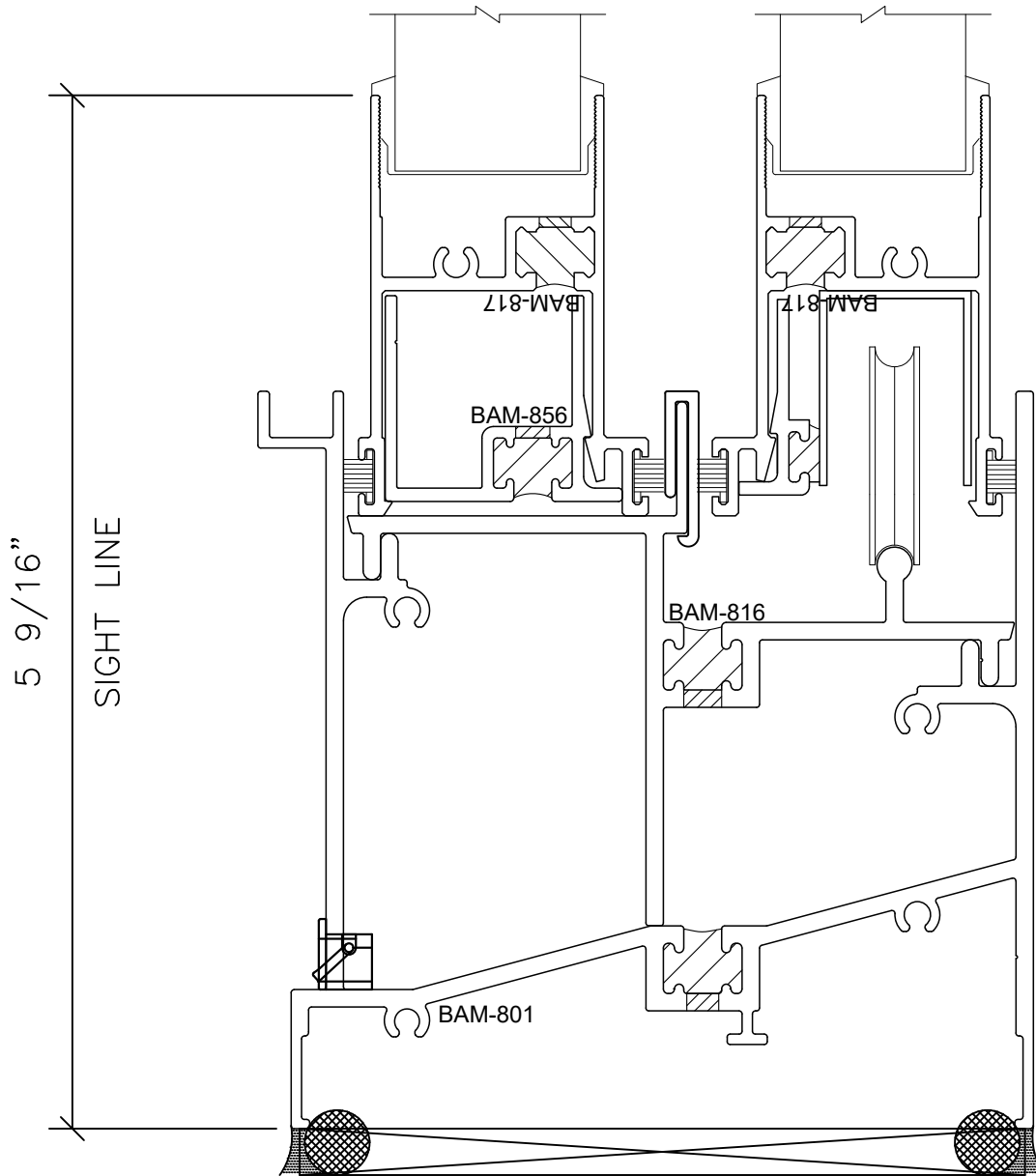
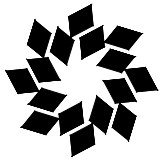

Let's Shine.

800.737.2800 • fax 417.862.1232 • BoydAluminum.com

©2016 Boyd Aluminum Manufacturing. The Boyd sunburst and logotype are trademarks of Boyd Aluminum Manufacturing.
All rights reserved. Due to continued product research, specifications are subject to change without notice.

910S-D3

040116

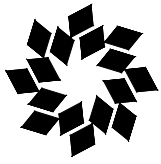

Boyd™

Series 910
Horizontal Sliding Window System

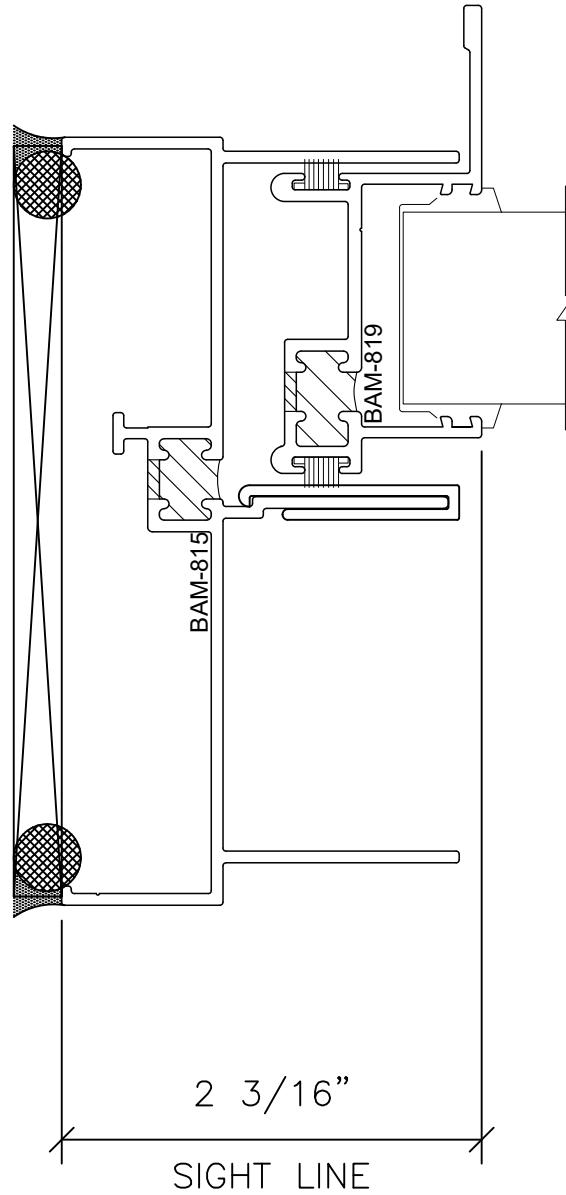

Let's Shine.

800.737.2800 • fax 417.862.1232 • BoydAluminum.com

©2016 Boyd Aluminum Manufacturing. The Boyd sunburst and logotype are trademarks of Boyd Aluminum Manufacturing.
All rights reserved. Due to continued product research, specifications are subject to change without notice.

910S-D4

040116

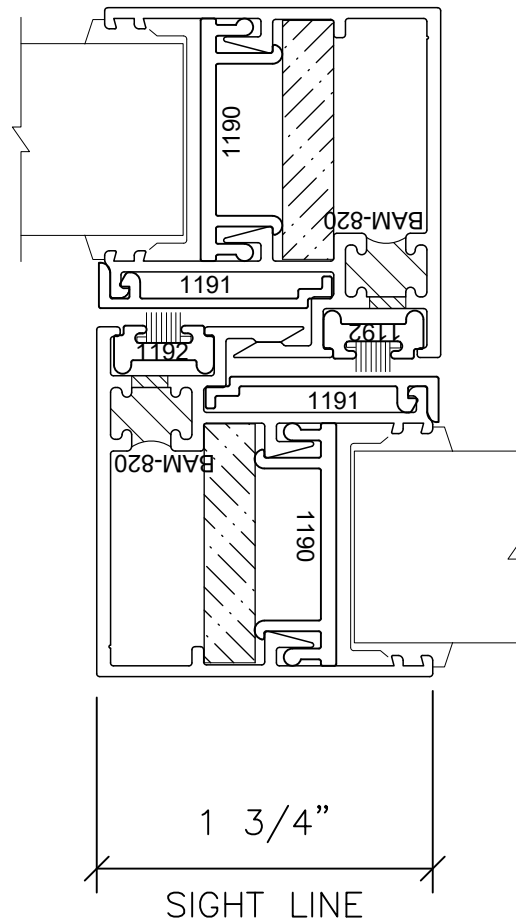

Let's Shine.

800.737.2800 • fax 417.862.1232 • BoydAluminum.com

©2016 Boyd Aluminum Manufacturing. The Boyd sunburst and logotype are trademarks of Boyd Aluminum Manufacturing.
All rights reserved. Due to continued product research, specifications are subject to change without notice.

910S-D5

040116

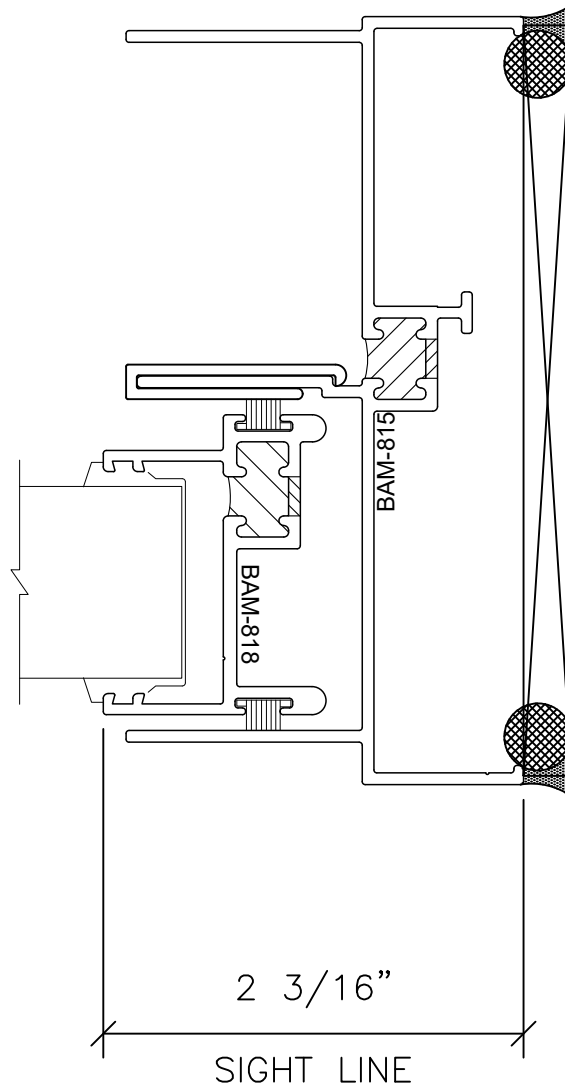

Let's Shine.

800.737.2800 • fax 417.862.1232 • BoydAluminum.com

©2016 Boyd Aluminum Manufacturing. The Boyd sunburst and logotype are trademarks of Boyd Aluminum Manufacturing.
All rights reserved. Due to continued product research, specifications are subject to change without notice.

910S-D6

040116

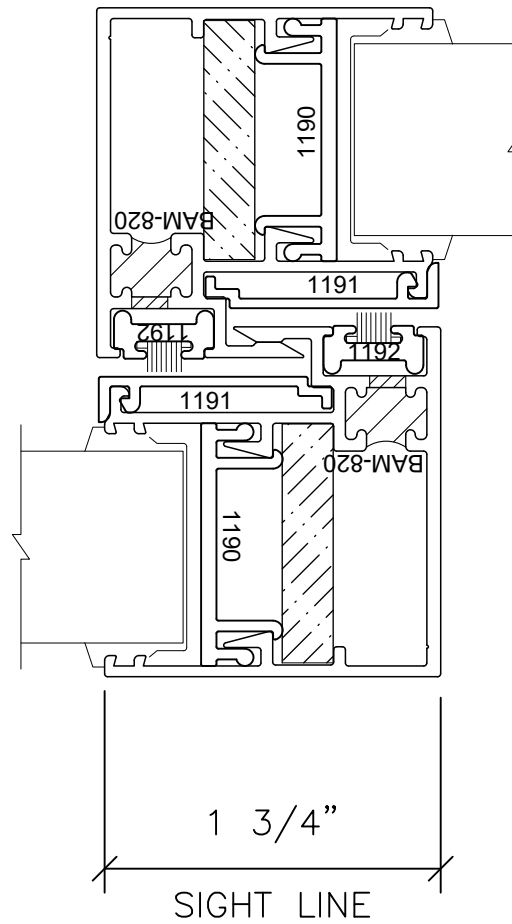

Let's Shine.

800.737.2800 • fax 417.862.1232 • BoydAluminum.com

©2016 Boyd Aluminum Manufacturing. The Boyd sunburst and logotype are trademarks of Boyd Aluminum Manufacturing.
All rights reserved. Due to continued product research, specifications are subject to change without notice.

910S-D7

040116

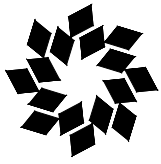

Boyd™

Series 910
Horizontal Sliding Window System

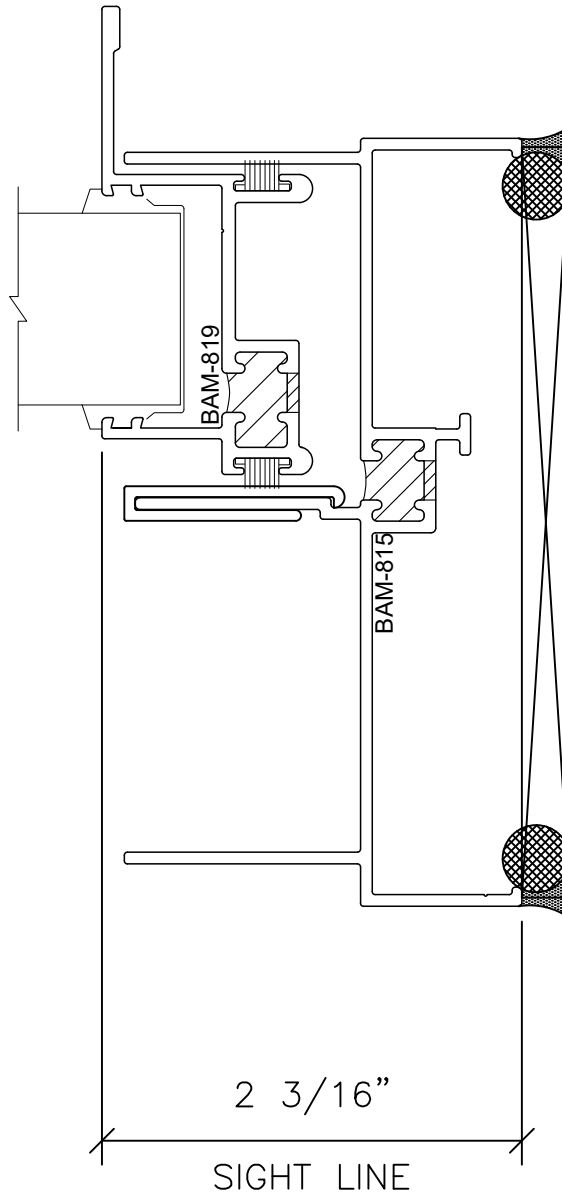

Let's Shine.

800.737.2800 • fax 417.862.1232 • BoydAluminum.com

©2016 Boyd Aluminum Manufacturing. The Boyd sunburst and logotype are trademarks of Boyd Aluminum Manufacturing.
All rights reserved. Due to continued product research, specifications are subject to change without notice.

910S-D8

040116

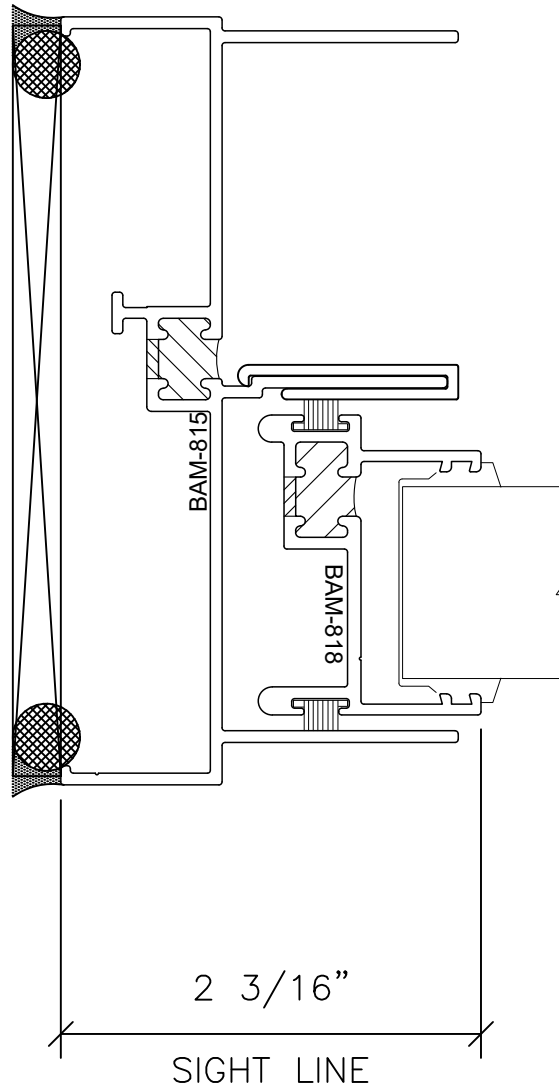

Let's Shine.

800.737.2800 • fax 417.862.1232 • BoydAluminum.com

©2016 Boyd Aluminum Manufacturing. The Boyd sunburst and logotype are trademarks of Boyd Aluminum Manufacturing.
All rights reserved. Due to continued product research, specifications are subject to change without notice.

910S-D9

040116

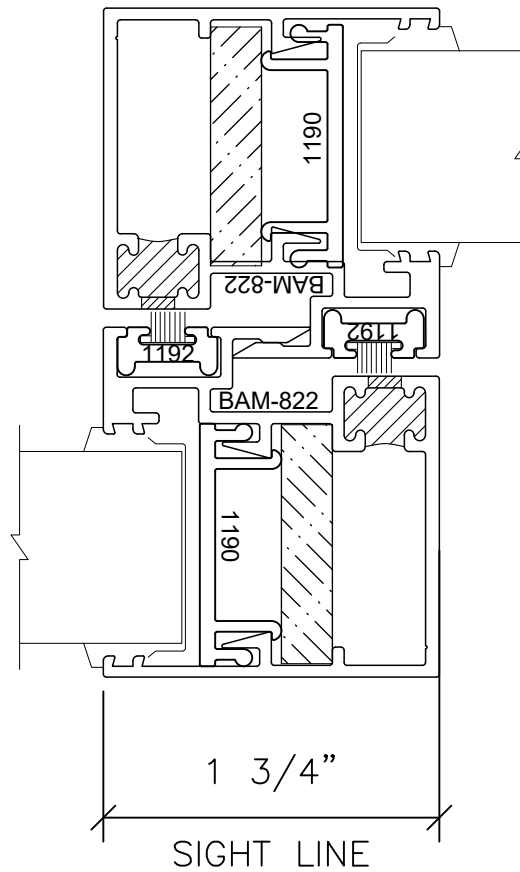

Let's Shine.

800.737.2800 • fax 417.862.1232 • BoydAluminum.com

©2016 Boyd Aluminum Manufacturing. The Boyd sunburst and logotype are trademarks of Boyd Aluminum Manufacturing.
All rights reserved. Due to continued product research, specifications are subject to change without notice.

910S-D10

040116

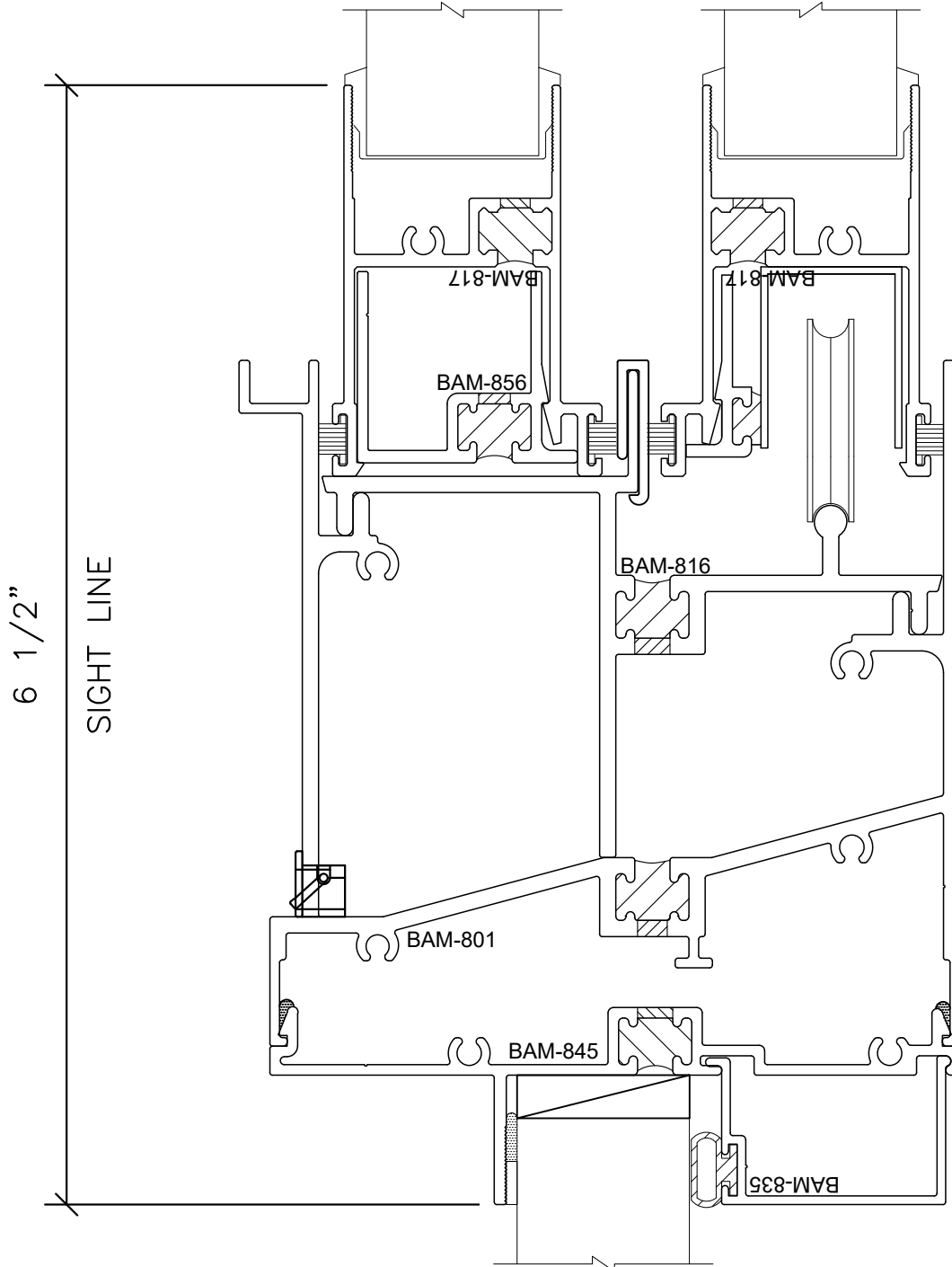

Let's Shine.

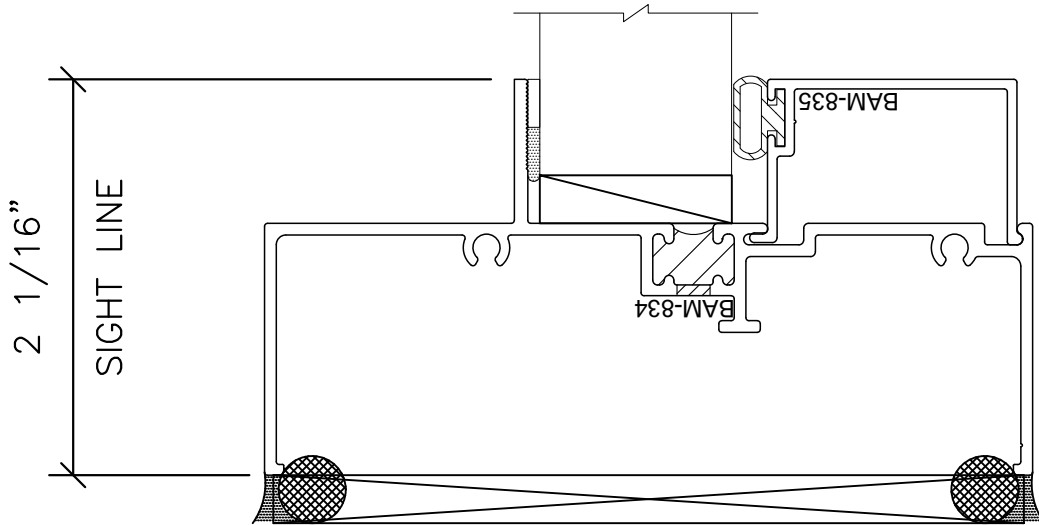

Let's Shine.

800.737.2800 • fax 417.862.1232 • BoydAluminum.com

©2016 Boyd Aluminum Manufacturing. The Boyd sunburst and logotype are trademarks of Boyd Aluminum Manufacturing.
All rights reserved. Due to continued product research, specifications are subject to change without notice.

910S-D12

040116

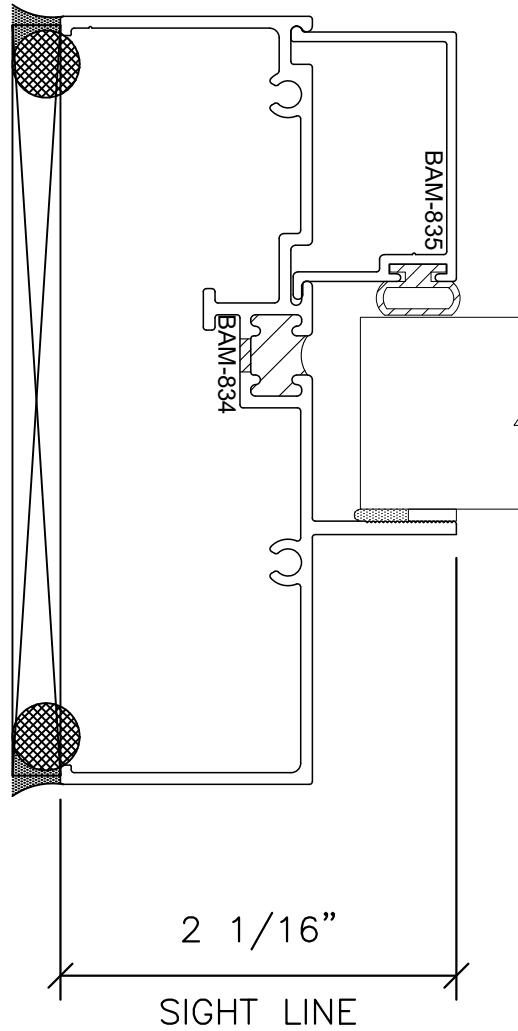

Let's Shine.

800.737.2800 • fax 417.862.1232 • BoydAluminum.com

©2016 Boyd Aluminum Manufacturing. The Boyd sunburst and logotype are trademarks of Boyd Aluminum Manufacturing.
All rights reserved. Due to continued product research, specifications are subject to change without notice.

D13
040116

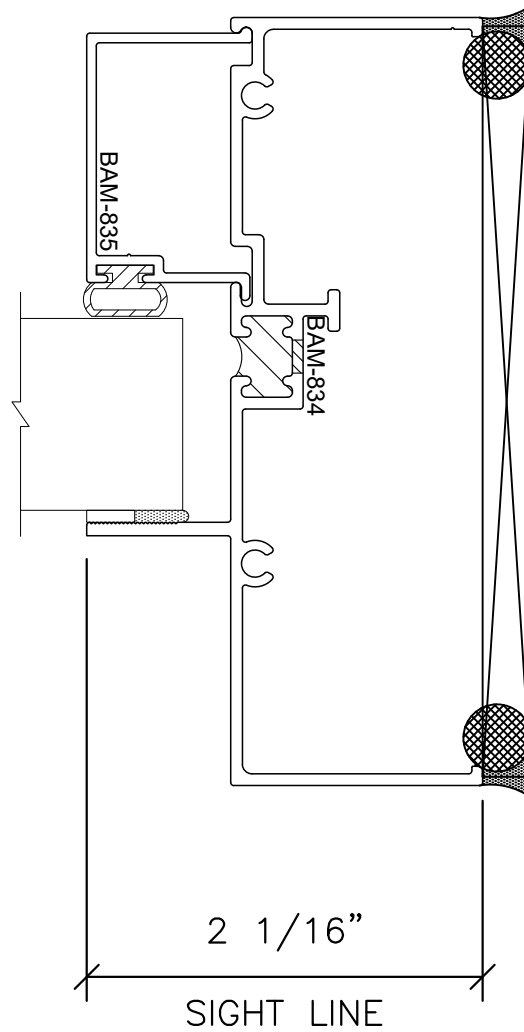
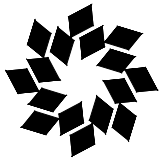

Let's Shine.

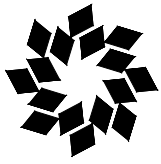

Boyd™

Series 910
Horizontal Sliding Window System

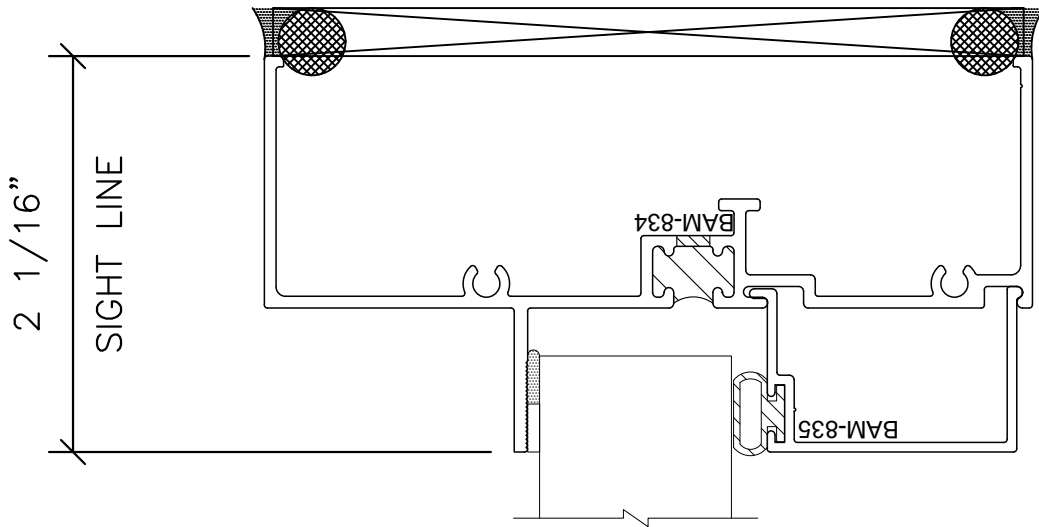

Let's Shine.

800.737.2800 • fax 417.862.1232 • BoydAluminum.com

©2016 Boyd Aluminum Manufacturing. The Boyd sunburst and logotype are trademarks of Boyd Aluminum Manufacturing.
All rights reserved. Due to continued product research, specifications are subject to change without notice.

D15
040116

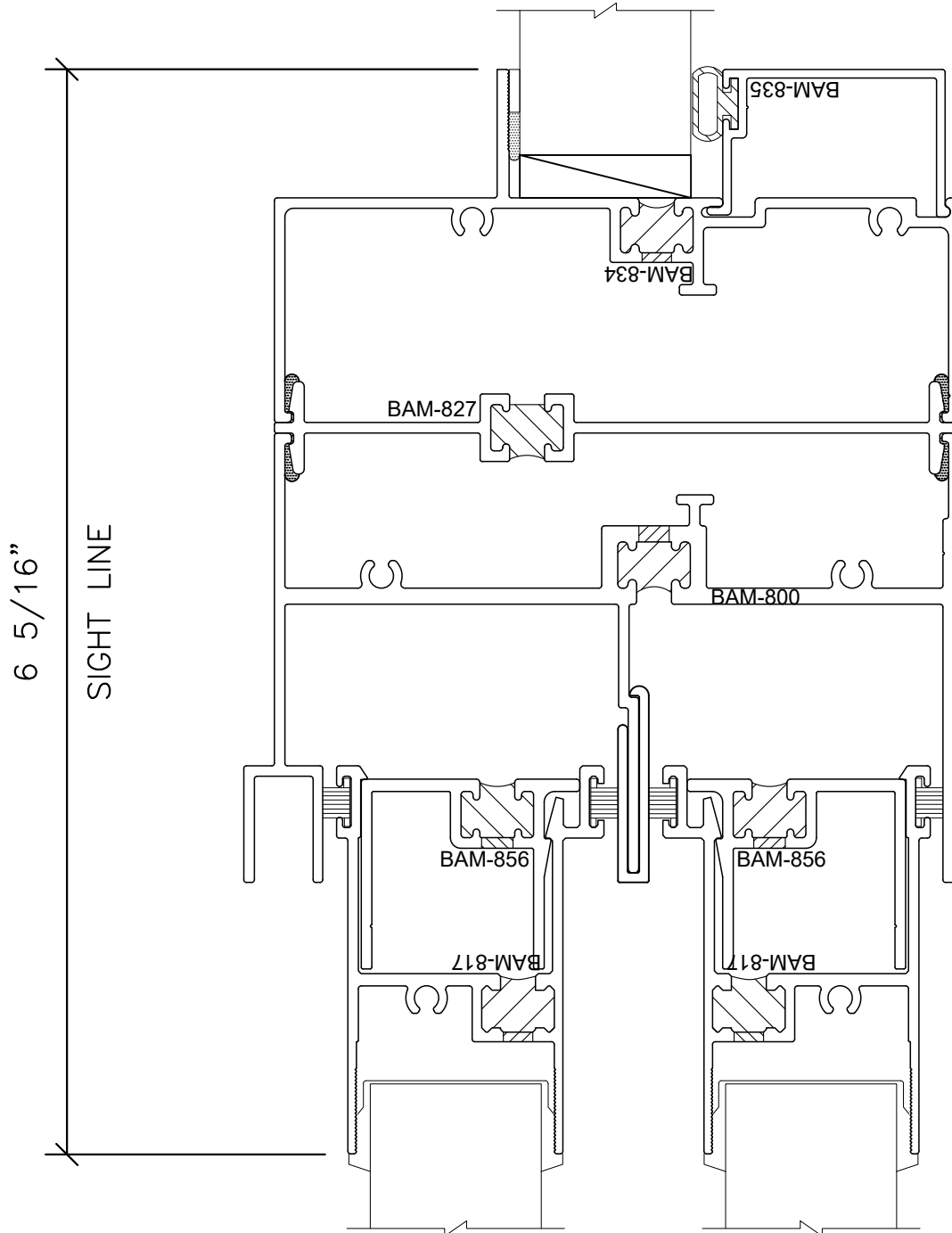
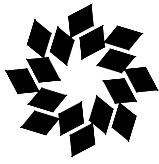

Let's Shine.

800.737.2800 • fax 417.862.1232 • BoydAluminum.com

©2016 Boyd Aluminum Manufacturing. The Boyd sunburst and logotype are trademarks of Boyd Aluminum Manufacturing.
All rights reserved. Due to continued product research, specifications are subject to change without notice.

D16
040116

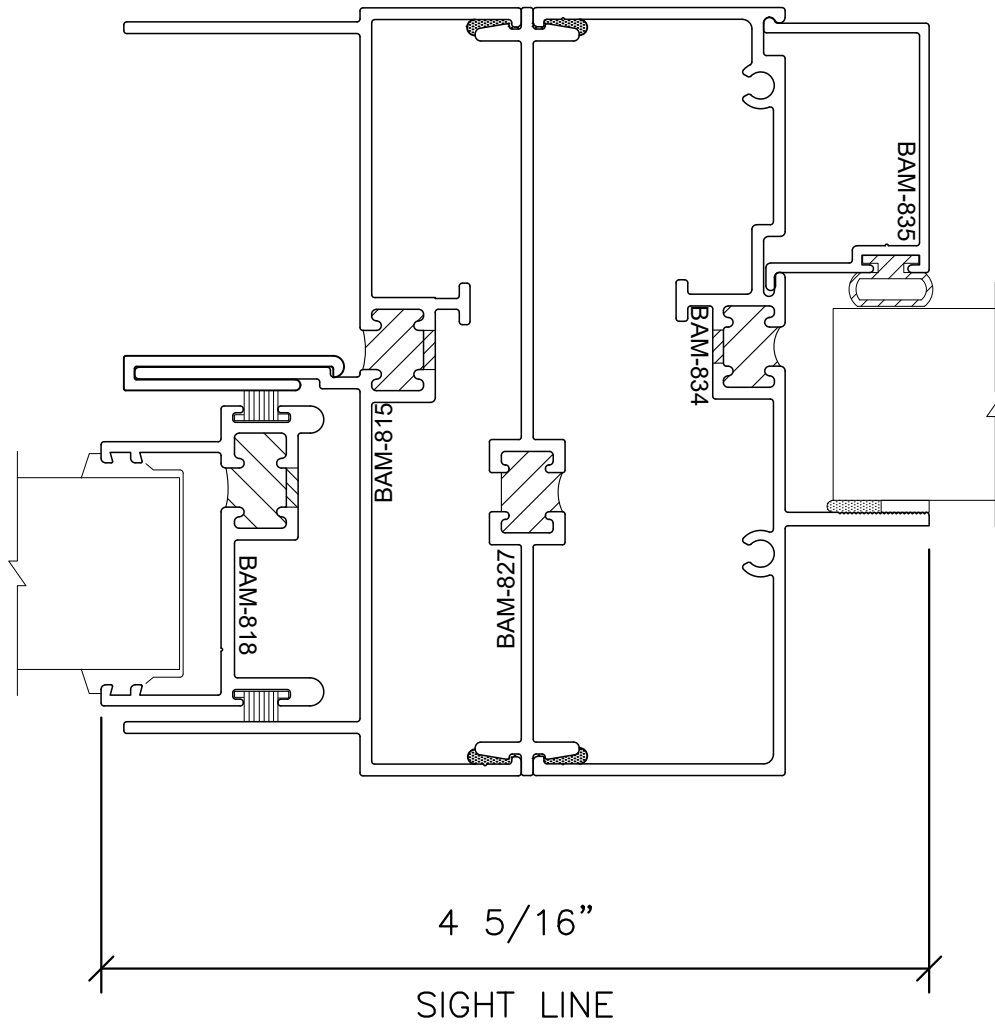
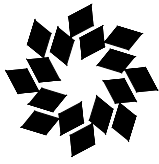

Let's Shine.

800.737.2800 • fax 417.862.1232 • BoydAluminum.com

©2016 Boyd Aluminum Manufacturing. The Boyd sunburst and logotype are trademarks of Boyd Aluminum Manufacturing. All rights reserved. Due to continued product research, specifications are subject to change without notice.

D17
040116

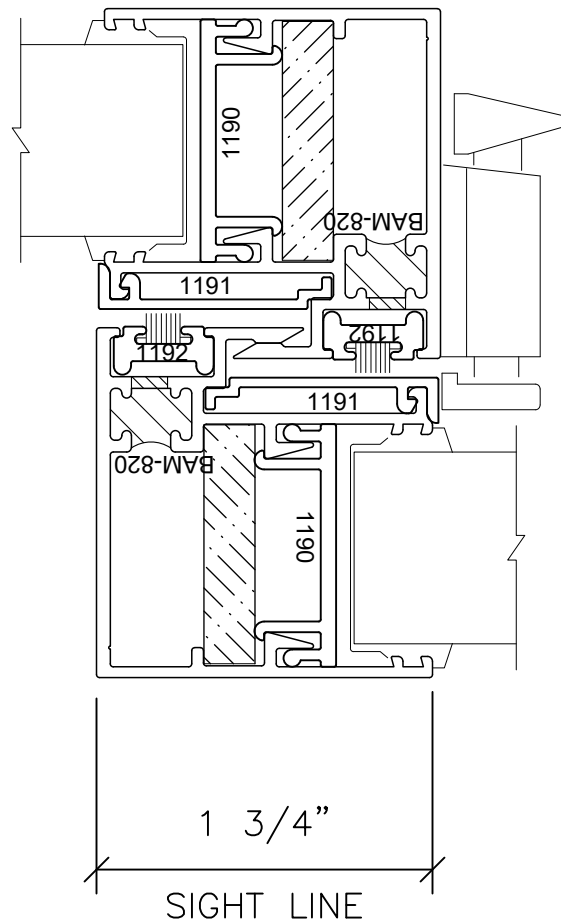

SWEEP LOCK

Let's Shine.

800.737.2800 • fax 417.862.1232 • BoydAluminum.com©2016 Boyd Aluminum Manufacturing. The Boyd sunburst and logotype are trademarks of Boyd Aluminum Manufacturing.
All rights reserved. Due to continued product research, specifications are subject to change without notice.H1
040116

GLAZING

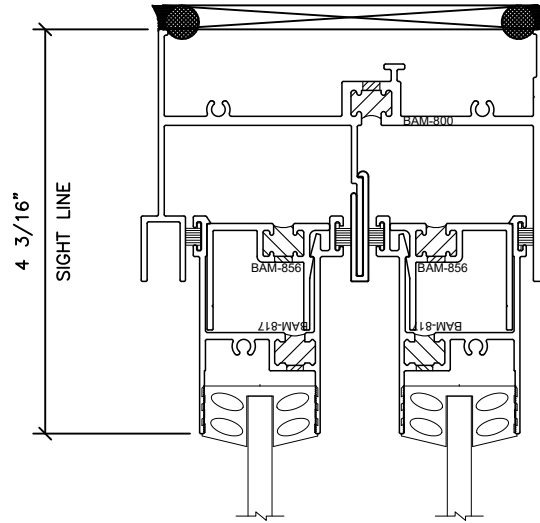

1/4" UNIT

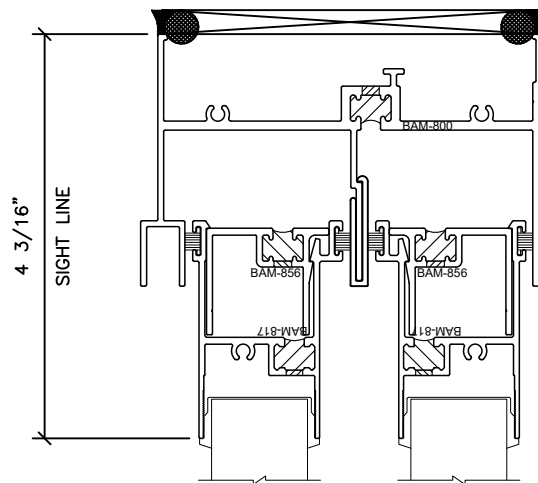

1" UNIT

Let's Shine.

800.737.2800 • fax 417.862.1232 • BoydAluminum.com

©2016 Boyd Aluminum Manufacturing. The Boyd sunburst and logotype are trademarks of Boyd Aluminum Manufacturing.
All rights reserved. Due to continued product research, specifications are subject to change without notice.