

Let's Shine.

800.737.2800 • fax 417.862.1232 • BoydAluminum.com

©2016 Boyd Aluminum Manufacturing. The Boyd sunburst and logotype are trademarks of Boyd Aluminum Manufacturing. All rights reserved. Due to continued product research, specifications are subject to change without notice.

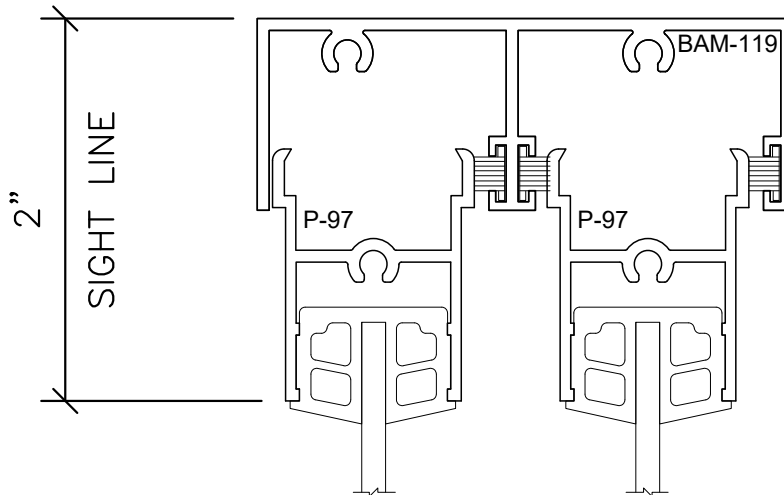

Let's Shine.

800.737.2800 • fax 417.862.1232 • BoydAluminum.com

©2016 Boyd Aluminum Manufacturing. The Boyd sunburst and logotype are trademarks of Boyd Aluminum Manufacturing.
All rights reserved. Due to continued product research, specifications are subject to change without notice.

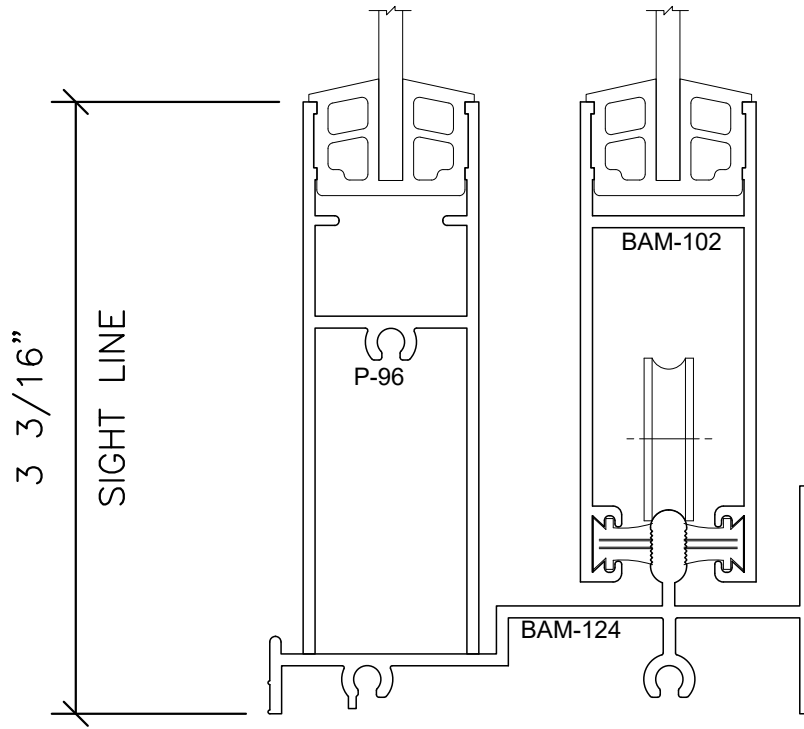

Let's Shine.

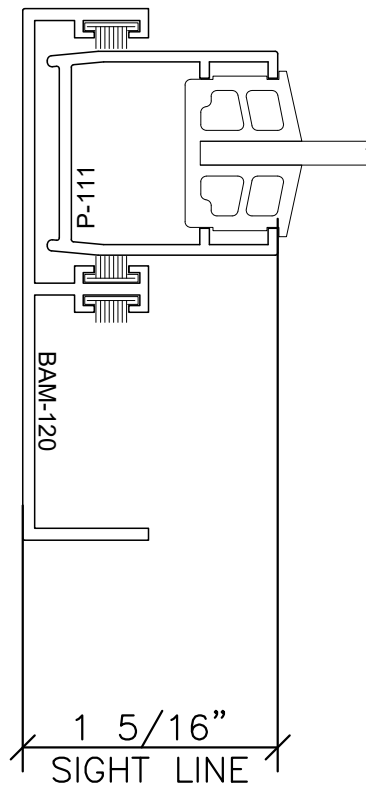

Let's Shine.

800.737.2800 • fax 417.862.1232 • BoydAluminum.com

©2016 Boyd Aluminum Manufacturing. The Boyd sunburst and logotype are trademarks of Boyd Aluminum Manufacturing.
All rights reserved. Due to continued product research, specifications are subject to change without notice.

D3
040116

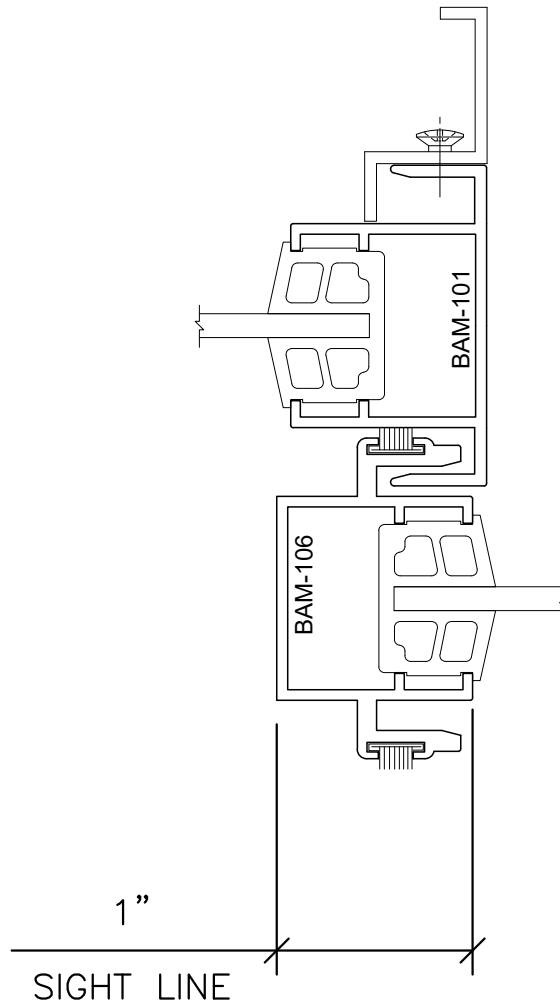

Let's Shine.

800.737.2800 • fax 417.862.1232 • BoydAluminum.com

©2016 Boyd Aluminum Manufacturing. The Boyd sunburst and logotype are trademarks of Boyd Aluminum Manufacturing.
All rights reserved. Due to continued product research, specifications are subject to change without notice.

D4
040116

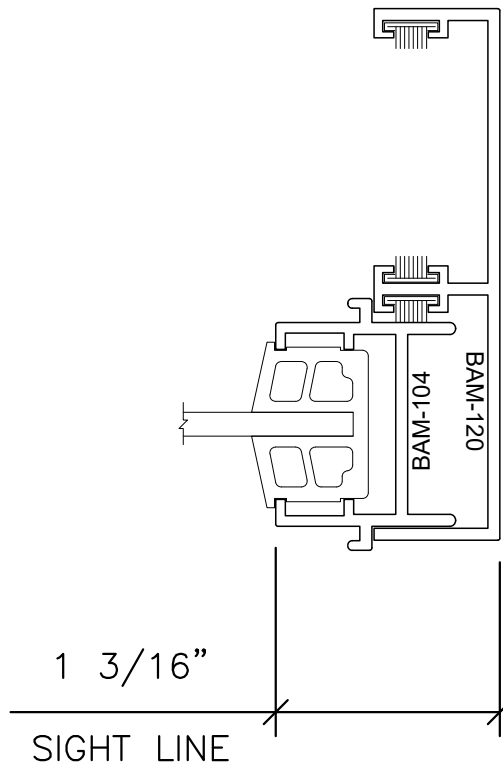

Let's Shine.

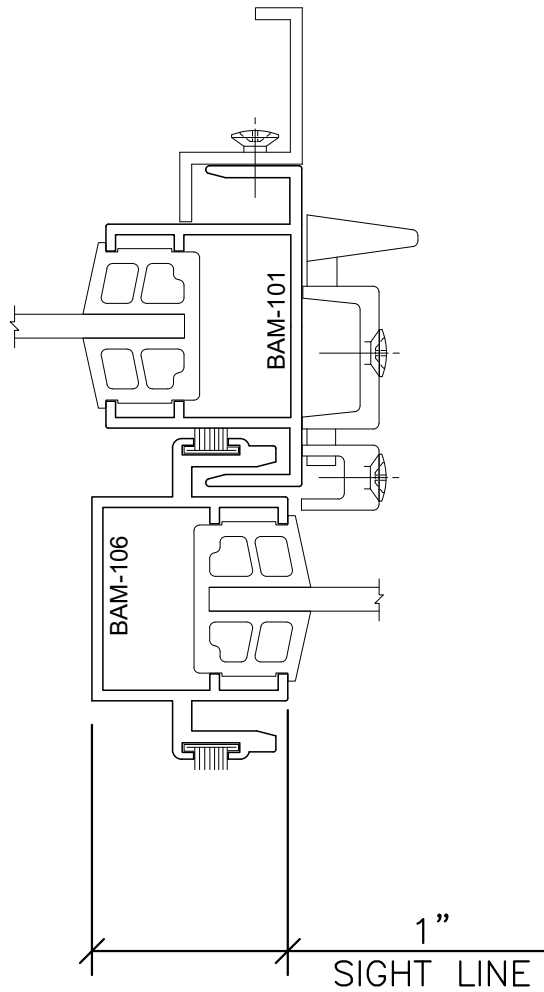

SWEEP LOCK

Let's Shine.

800.737.2800 • fax 417.862.1232 • BoydAluminum.com©2016 Boyd Aluminum Manufacturing. The Boyd sunburst and logotype are trademarks of Boyd Aluminum Manufacturing.
All rights reserved. Due to continued product research, specifications are subject to change without notice.H1
040116

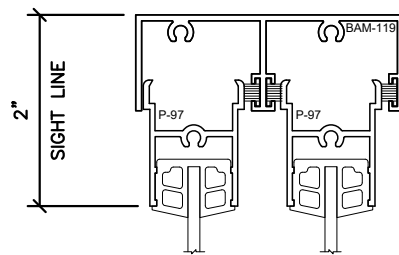

1/8" UNIT

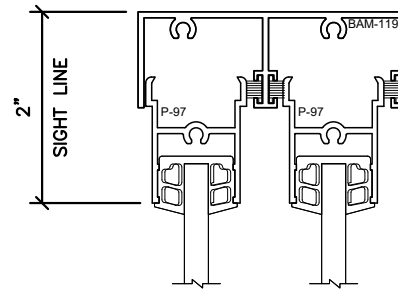

1/4" UNIT

GLAZING

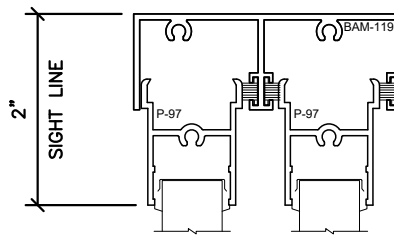

5/8" UNIT

Let's Shine.