

HORIZONTAL SLIDER (XO)

Let's Shine.

800.737.2800 • fax 417.862.1232 • BoydAluminum.com

©2016 Boyd Aluminum Manufacturing. The Boyd sunburst and logotype are trademarks of Boyd Aluminum Manufacturing. All rights reserved. Due to continued product research, specification are subject to change without notice.

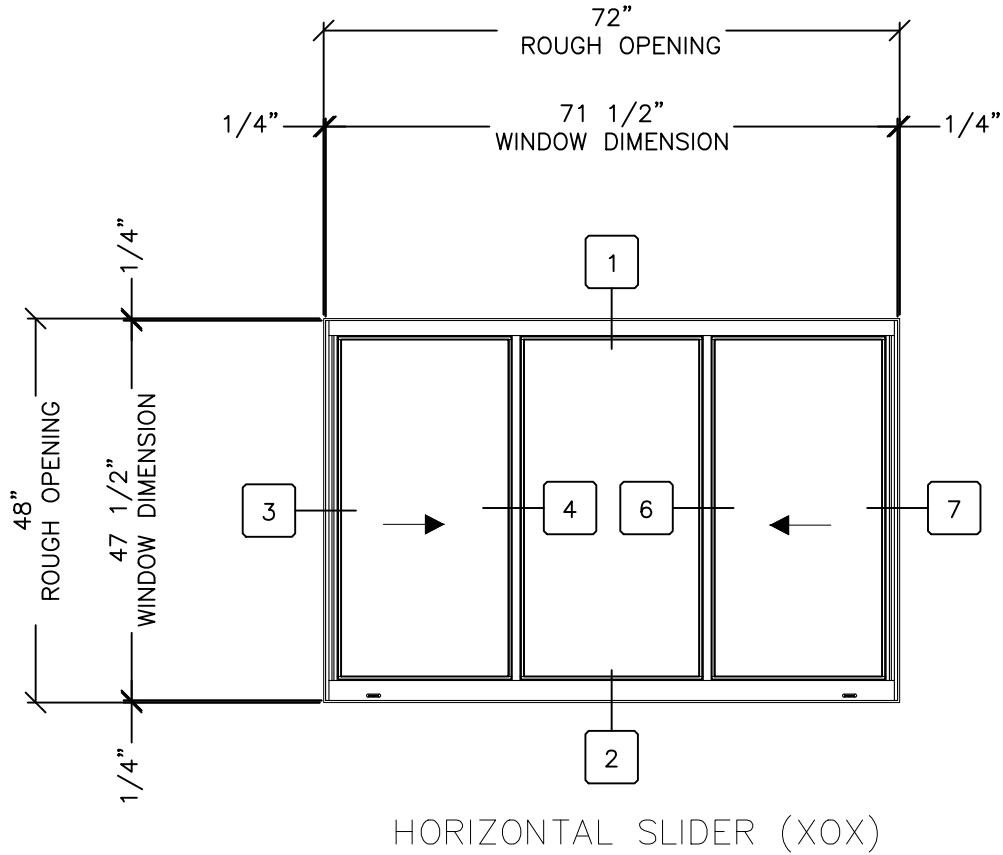

Let's Shine.

800.737.2800 • fax 417.862.1232 • BoydAluminum.com

©2016 Boyd Aluminum Manufacturing. The Boyd sunburst and logotype are trademarks of Boyd Aluminum Manufacturing.
All rights reserved. Due to continued product research, specifications are subject to change without notice.

E2
040116

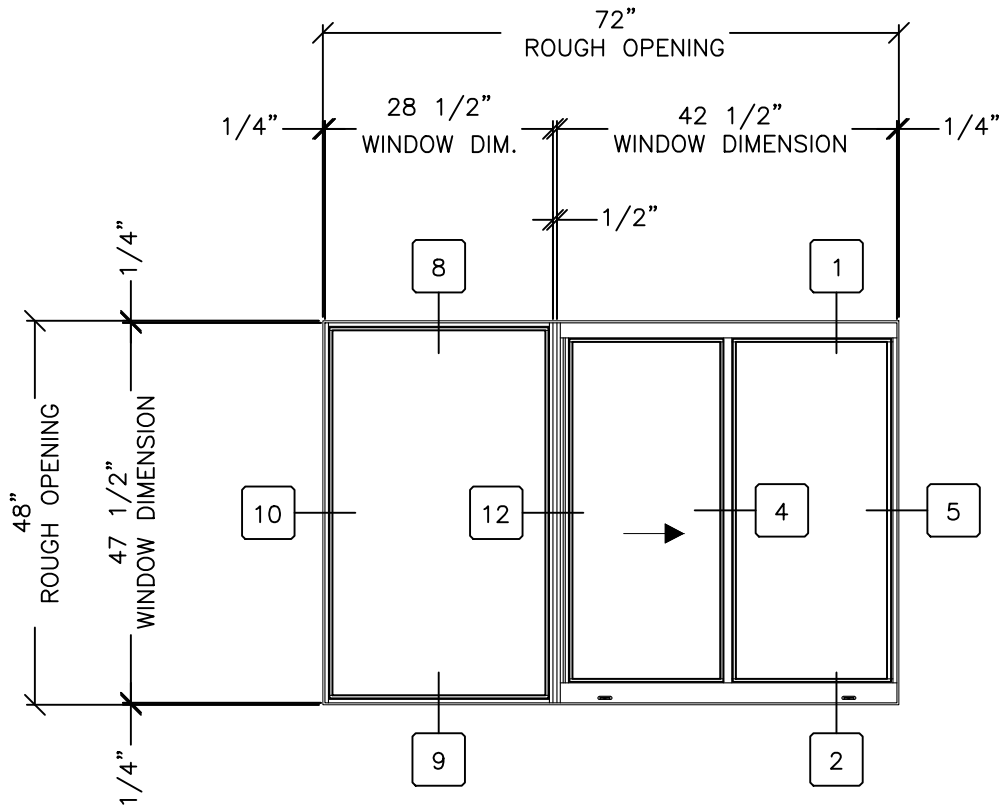
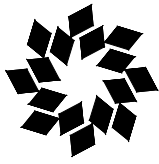

FIXED / HORIZONTAL SLIDER (XO)

Let's Shine.

800.737.2800 • fax 417.862.1232 • BoydAluminum.com

©2016 Boyd Aluminum Manufacturing. The Boyd sunburst and logotype are trademarks of Boyd Aluminum Manufacturing. All rights reserved. Due to continued product research, specifications are subject to change without notice.

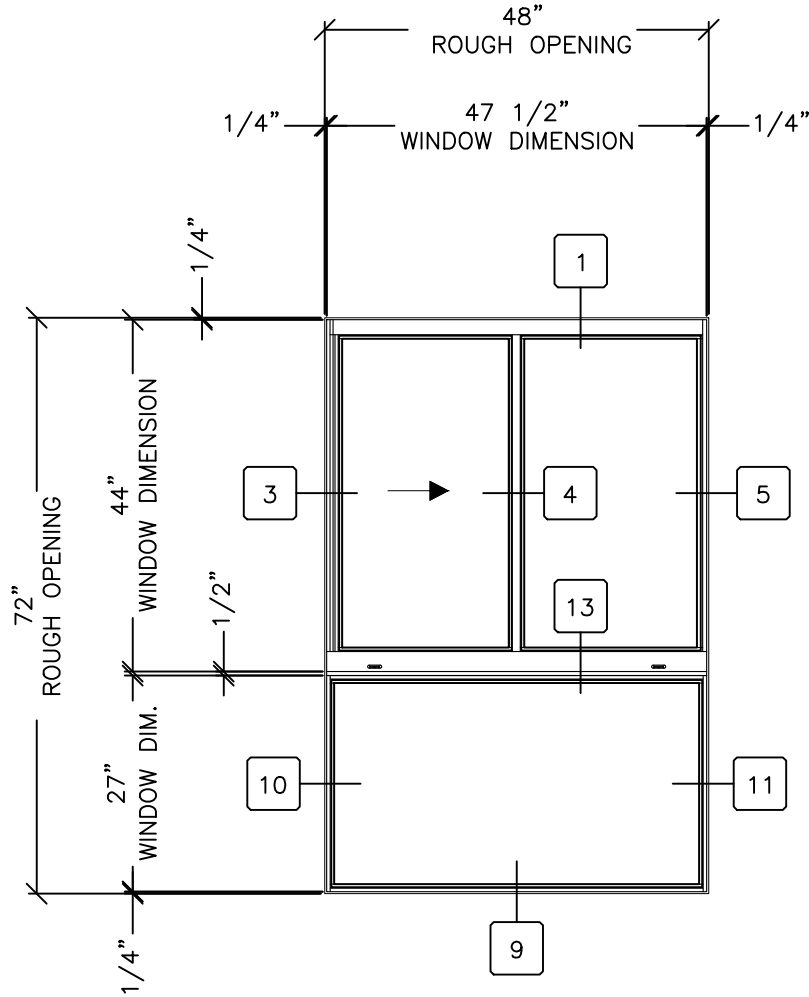
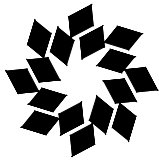

HORIZONTAL SLIDER (XO) / FIXED

Let's Shine.

800.737.2800 • fax 417.862.1232 • BoydAluminum.com

©2016 Boyd Aluminum Manufacturing. The Boyd sunburst and logotype are trademarks of Boyd Aluminum Manufacturing. All rights reserved. Due to continued product research, specifications are subject to change without notice.

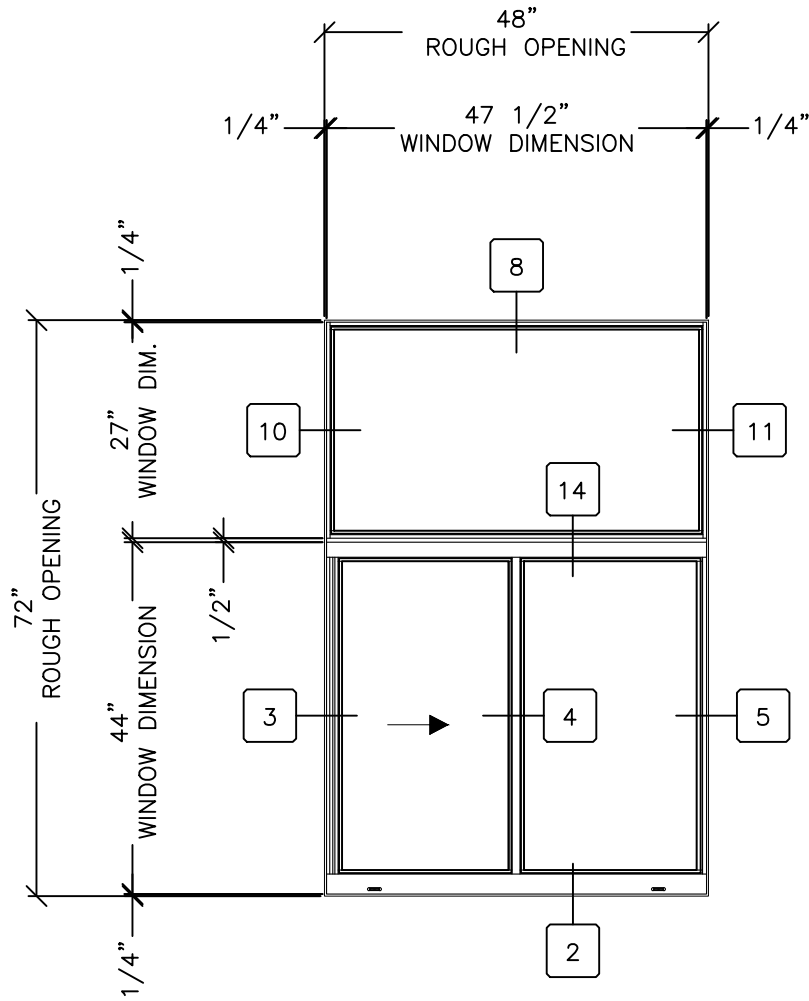
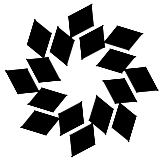

FIXED / HORIZONTAL SLIDER (XO)

Let's Shine.

800.737.2800 • fax 417.862.1232 • BoydAluminum.com

©2016 Boyd Aluminum Manufacturing. The Boyd sunburst and logotype are trademarks of Boyd Aluminum Manufacturing. All rights reserved. Due to continued product research, specifications are subject to change without notice.

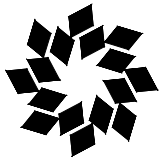

Boyd™

Series 600
Horizontal Sliding Window System

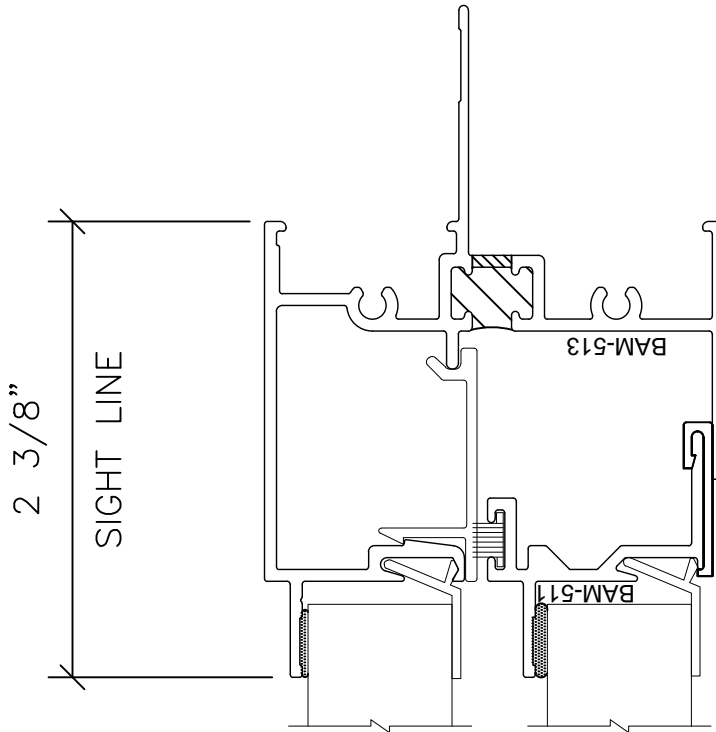

Let's Shine.

800.737.2800 • fax 417.862.1232 • BoydAluminum.com

©2016 Boyd Aluminum Manufacturing. The Boyd sunburst and logotype are trademarks of Boyd Aluminum Manufacturing.

All rights reserved. Due to continued product research, specifications are subject to change without notice.

D1
040116

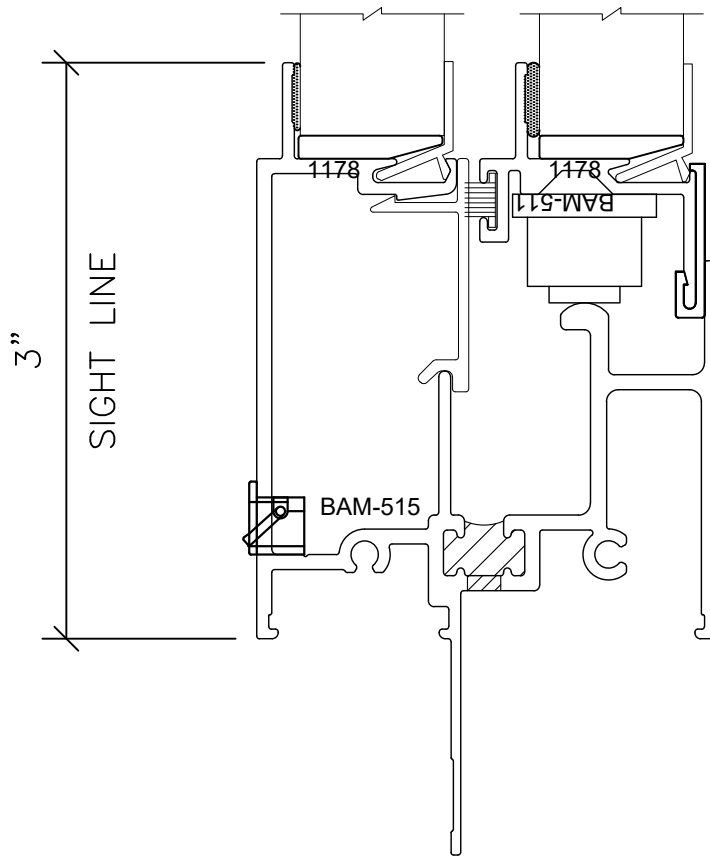
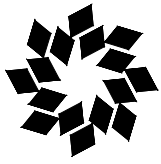

Let's Shine.

800.737.2800 • fax 417.862.1232 • BoydAluminum.com

©2016 Boyd Aluminum Manufacturing. The Boyd sunburst and logotype are trademarks of Boyd Aluminum Manufacturing.
All rights reserved. Due to continued product research, specifications are subject to change without notice.

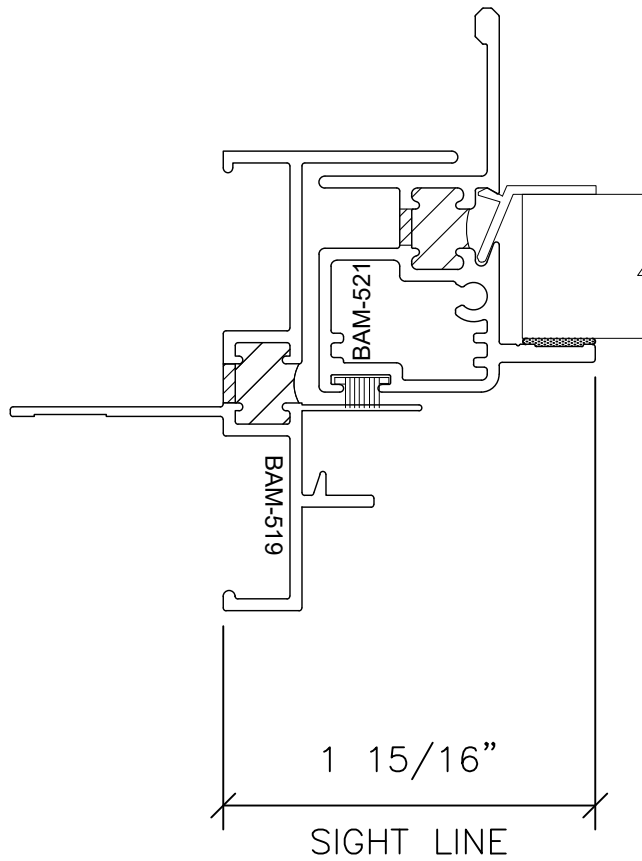

Let's Shine.

800.737.2800 • fax 417.862.1232 • BoydAluminum.com

©2016 Boyd Aluminum Manufacturing. The Boyd sunburst and logotype are trademarks of Boyd Aluminum Manufacturing.
All rights reserved. Due to continued product research, specifications are subject to change without notice.

D3
040116

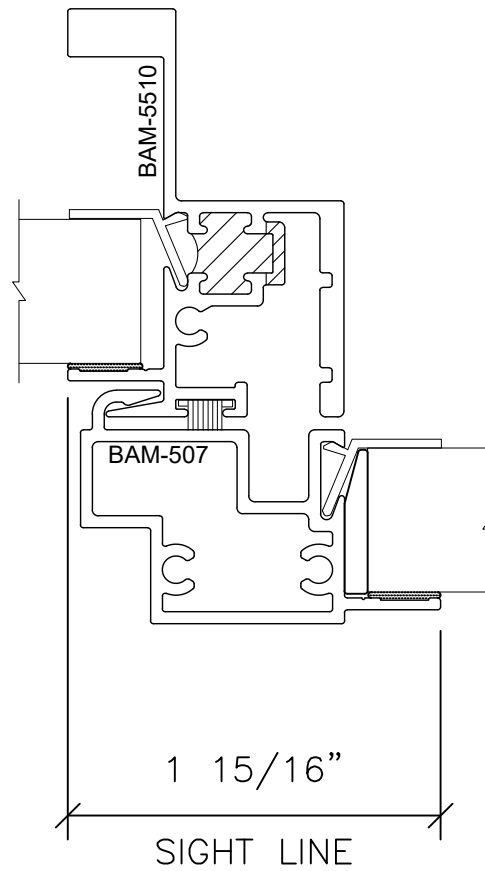

Let's Shine.

800.737.2800 • fax 417.862.1232 • BoydAluminum.com

©2016 Boyd Aluminum Manufacturing. The Boyd sunburst and logotype are trademarks of Boyd Aluminum Manufacturing.
All rights reserved. Due to continued product research, specifications are subject to change without notice.

D4
040116

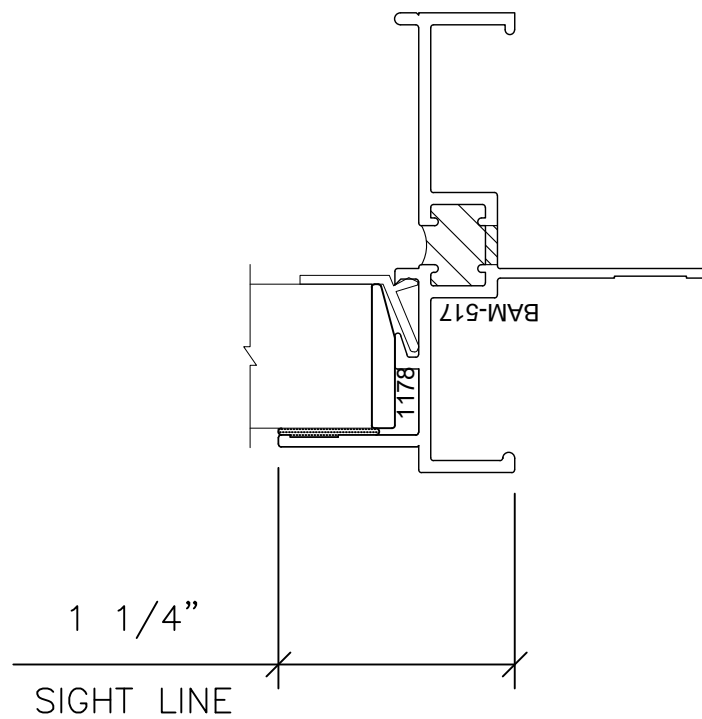

Let's Shine.

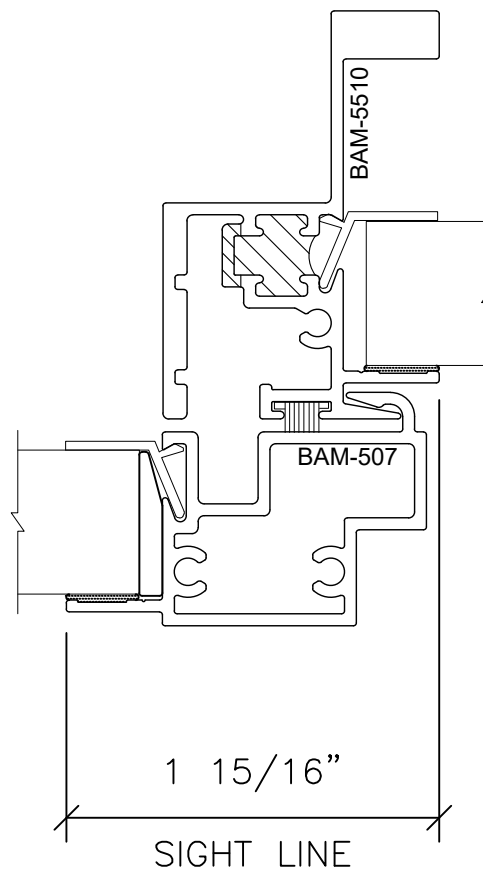

Let's Shine.

800.737.2800 • fax 417.862.1232 • BoydAluminum.com

©2016 Boyd Aluminum Manufacturing. The Boyd sunburst and logotype are trademarks of Boyd Aluminum Manufacturing.
All rights reserved. Due to continued product research, specifications are subject to change without notice.

D6
040116

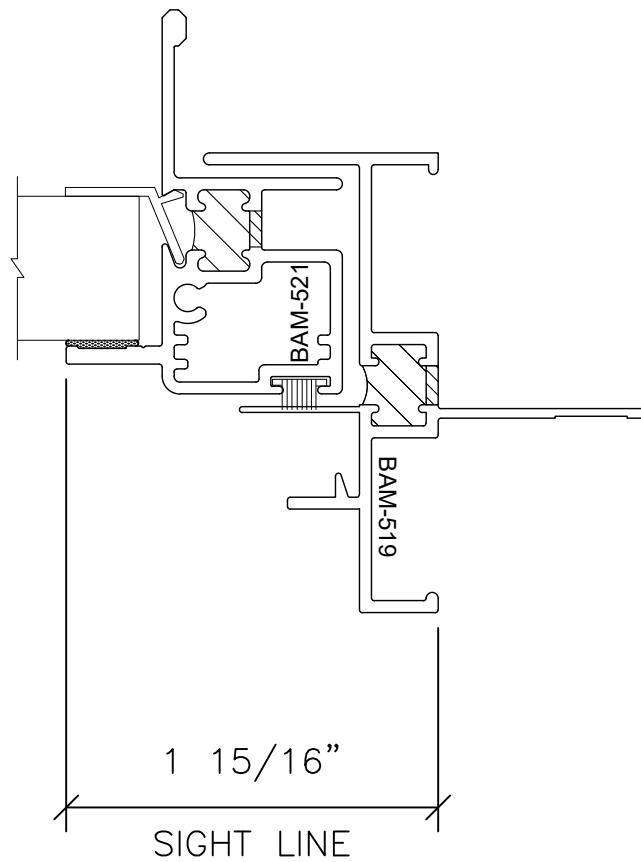

Let's Shine.

800.737.2800 • fax 417.862.1232 • BoydAluminum.com

©2016 Boyd Aluminum Manufacturing. The Boyd sunburst and logotype are trademarks of Boyd Aluminum Manufacturing.
All rights reserved. Due to continued product research, specifications are subject to change without notice.

D7
040116

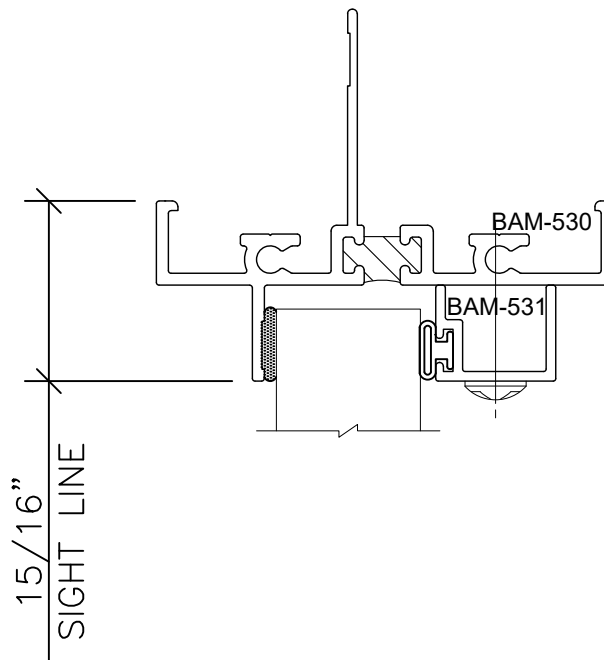

Let's Shine.

800.737.2800 • fax 417.862.1232 • BoydAluminum.com

©2016 Boyd Aluminum Manufacturing. The Boyd sunburst and logotype are trademarks of Boyd Aluminum Manufacturing.
All rights reserved. Due to continued product research, specifications are subject to change without notice.

D8
040116

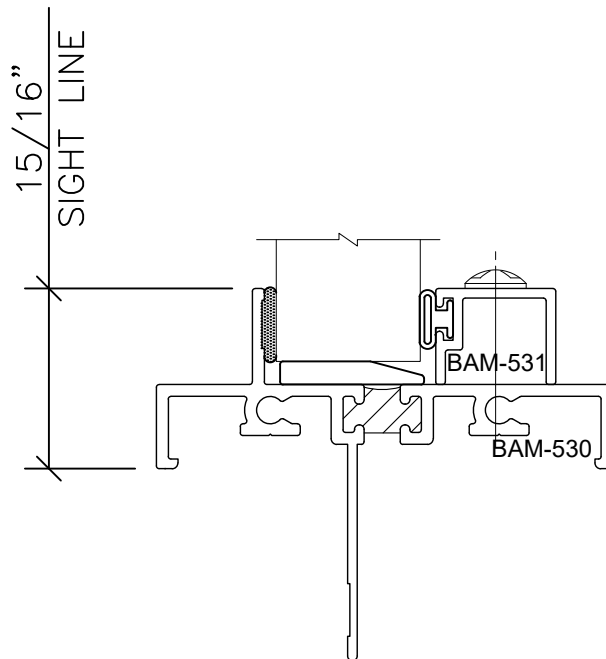

Let's Shine.

800.737.2800 • fax 417.862.1232 • BoydAluminum.com

©2016 Boyd Aluminum Manufacturing. The Boyd sunburst and logotype are trademarks of Boyd Aluminum Manufacturing.
All rights reserved. Due to continued product research, specifications are subject to change without notice.

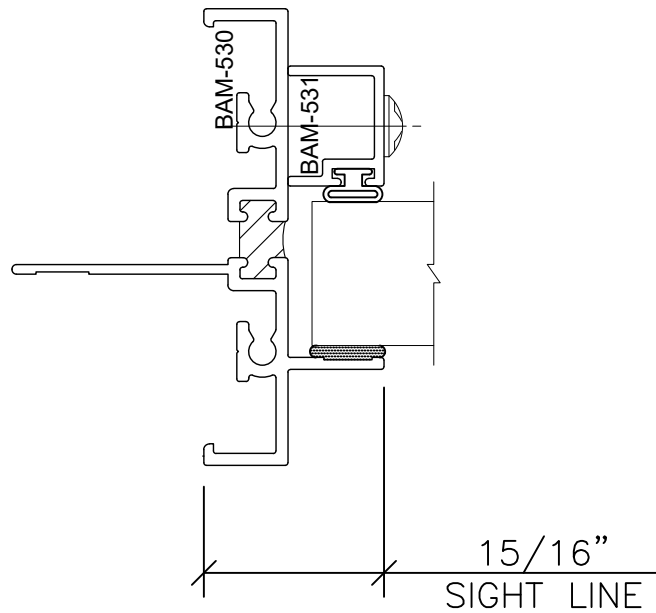

Let's Shine.

800.737.2800 • fax 417.862.1232 • BoydAluminum.com

©2016 Boyd Aluminum Manufacturing. The Boyd sunburst and logotype are trademarks of Boyd Aluminum Manufacturing.
All rights reserved. Due to continued product research, specifications are subject to change without notice.

D10
040116

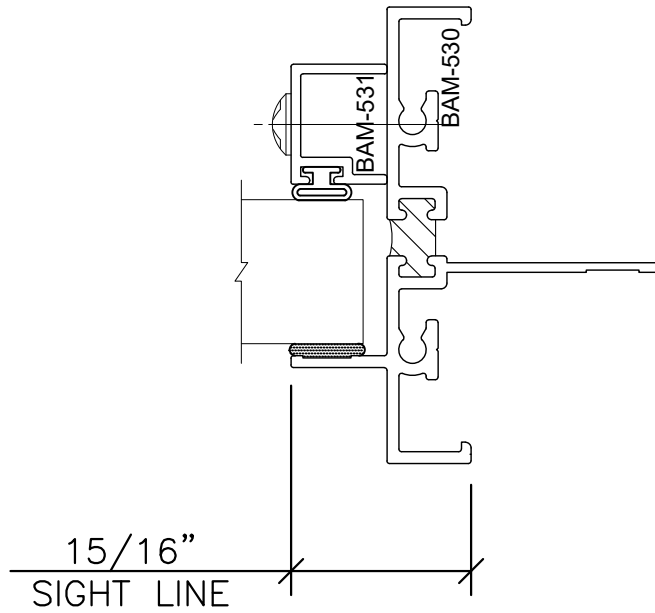

Let's Shine.

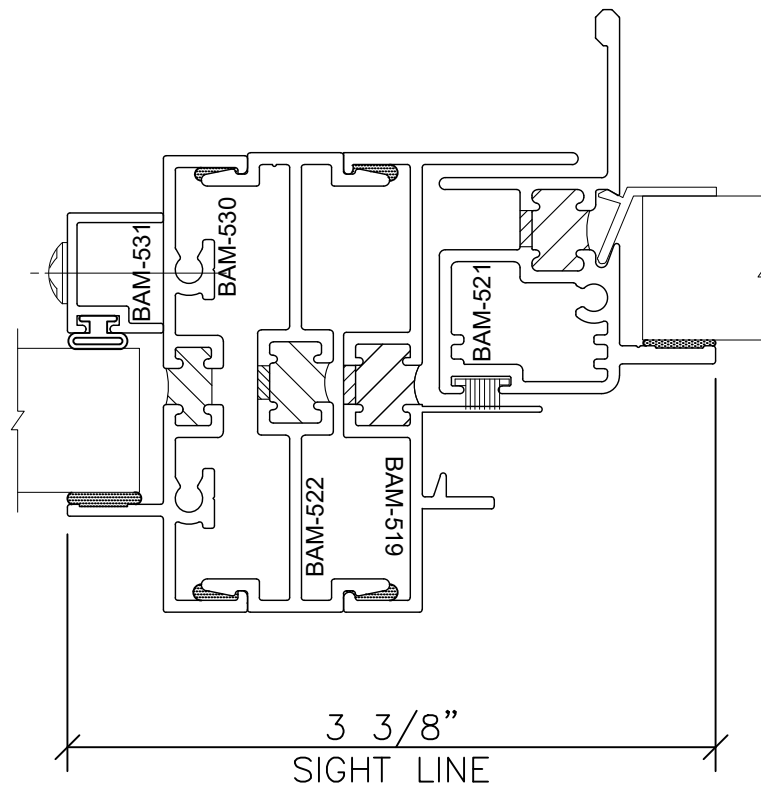

Let's Shine.

800.737.2800 • fax 417.862.1232 • BoydAluminum.com

©2016 Boyd Aluminum Manufacturing. The Boyd sunburst and logotype are trademarks of Boyd Aluminum Manufacturing.
All rights reserved. Due to continued product research, specifications are subject to change without notice.

D12
040116

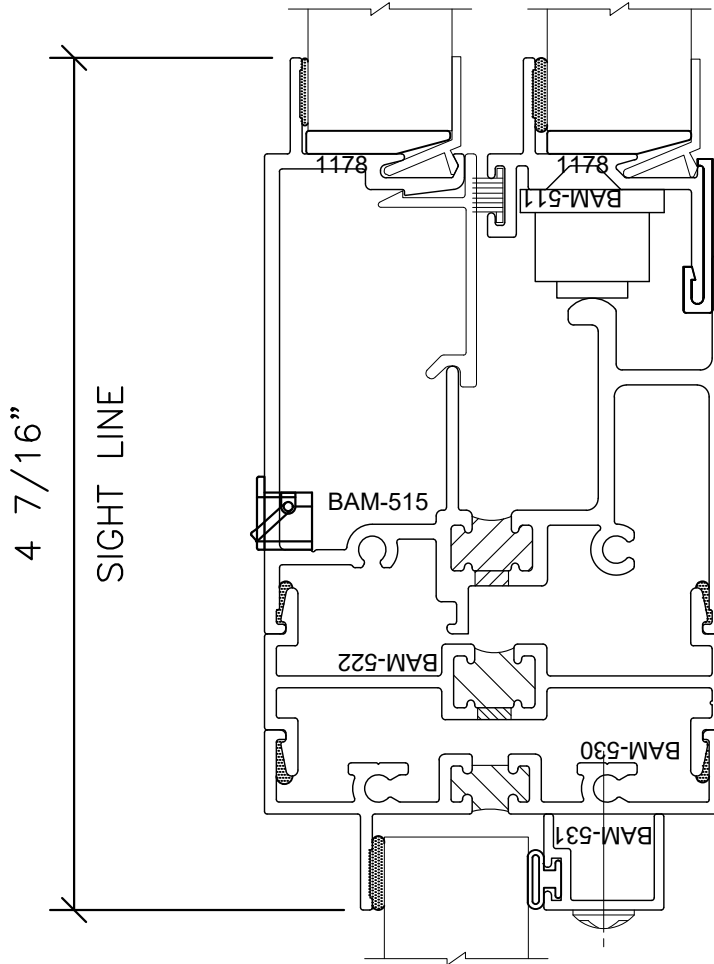
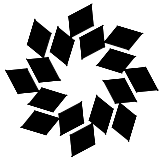

Let's Shine.

800.737.2800 • fax 417.862.1232 • BoydAluminum.com

©2016 Boyd Aluminum Manufacturing. The Boyd sunburst and logotype are trademarks of Boyd Aluminum Manufacturing.
All rights reserved. Due to continued product research, specifications are subject to change without notice.

D13

040116

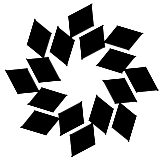

Boyd™

Series 600
Horizontal Sliding Window System

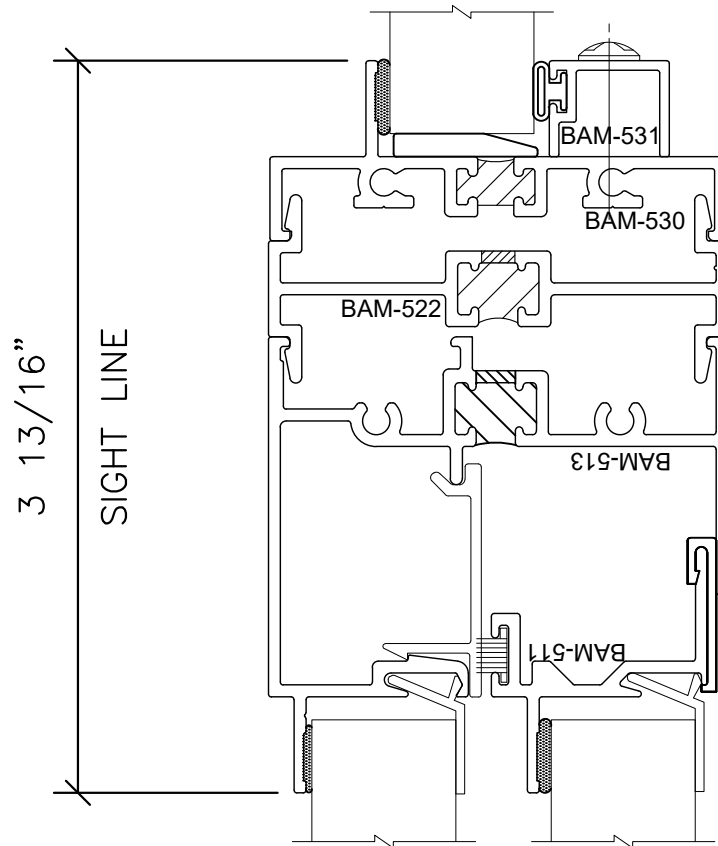

Let's Shine.

800.737.2800 • fax 417.862.1232 • BoydAluminum.com

©2016 Boyd Aluminum Manufacturing. The Boyd sunburst and logotype are trademarks of Boyd Aluminum Manufacturing.
All rights reserved. Due to continued product research, specifications are subject to change without notice.

D14
040116

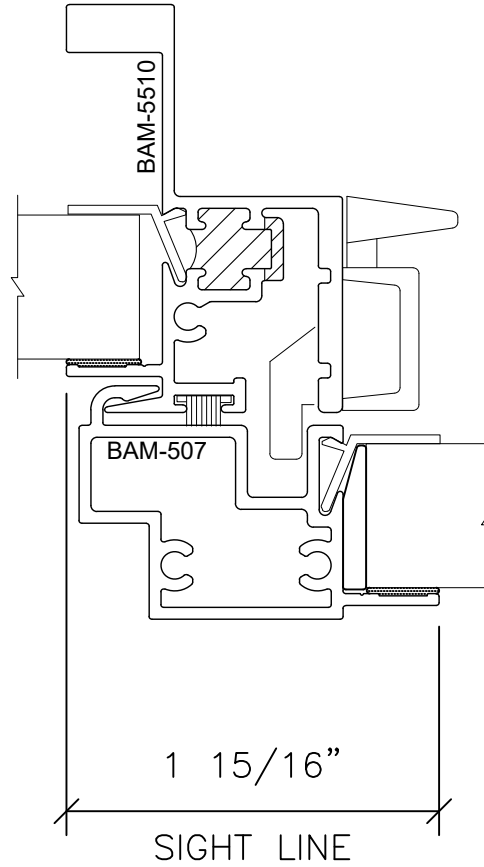

SWEEP LOCK

Let's Shine.

800.737.2800 • fax 417.862.1232 • BoydAluminum.com©2016 Boyd Aluminum Manufacturing. The Boyd sunburst and logotype are trademarks of Boyd Aluminum Manufacturing.
All rights reserved. Due to continued product research, specifications are subject to change without notice.H1
040116

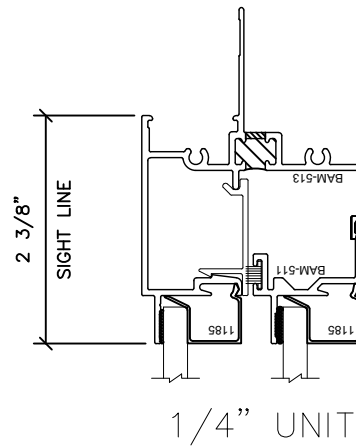
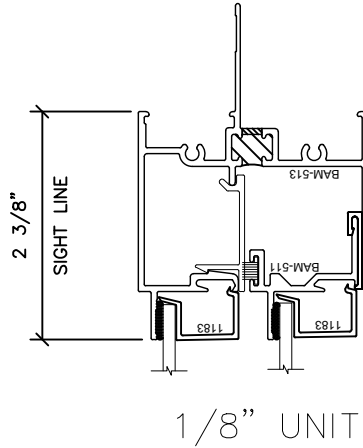

GLAZING

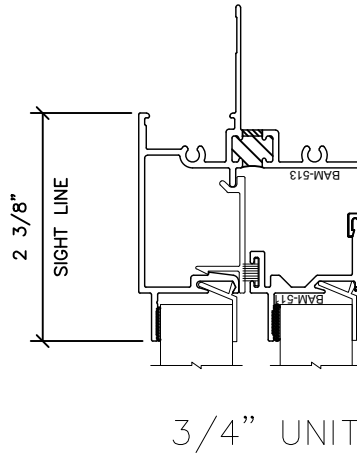

Let's Shine.