

Let's Shine.

800.737.2800 • fax 417.862.1232 • BoydAluminum.com

©2016 Boyd Aluminum Manufacturing. The Boyd sunburst and logotype are trademarks of Boyd Aluminum Manufacturing.
All rights reserved. Due to continued product research, specifications are subject to change without notice.

E1
040116

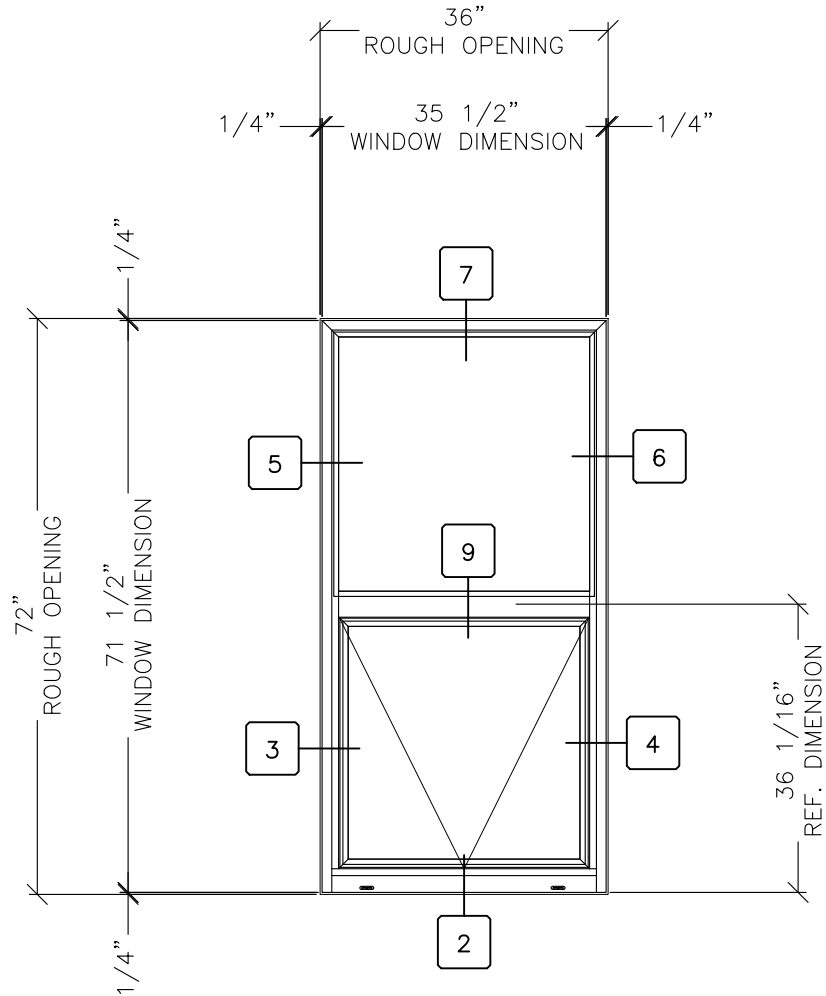

FIXED / PROJECT IN

Let's Shine.

800.737.2800 • fax 417.862.1232 • BoydAluminum.com

©2016 Boyd Aluminum Manufacturing. The Boyd sunburst and logotype are trademarks of Boyd Aluminum Manufacturing. All rights reserved. Due to continued product research, specification are subject to change without notice.

E2
040116

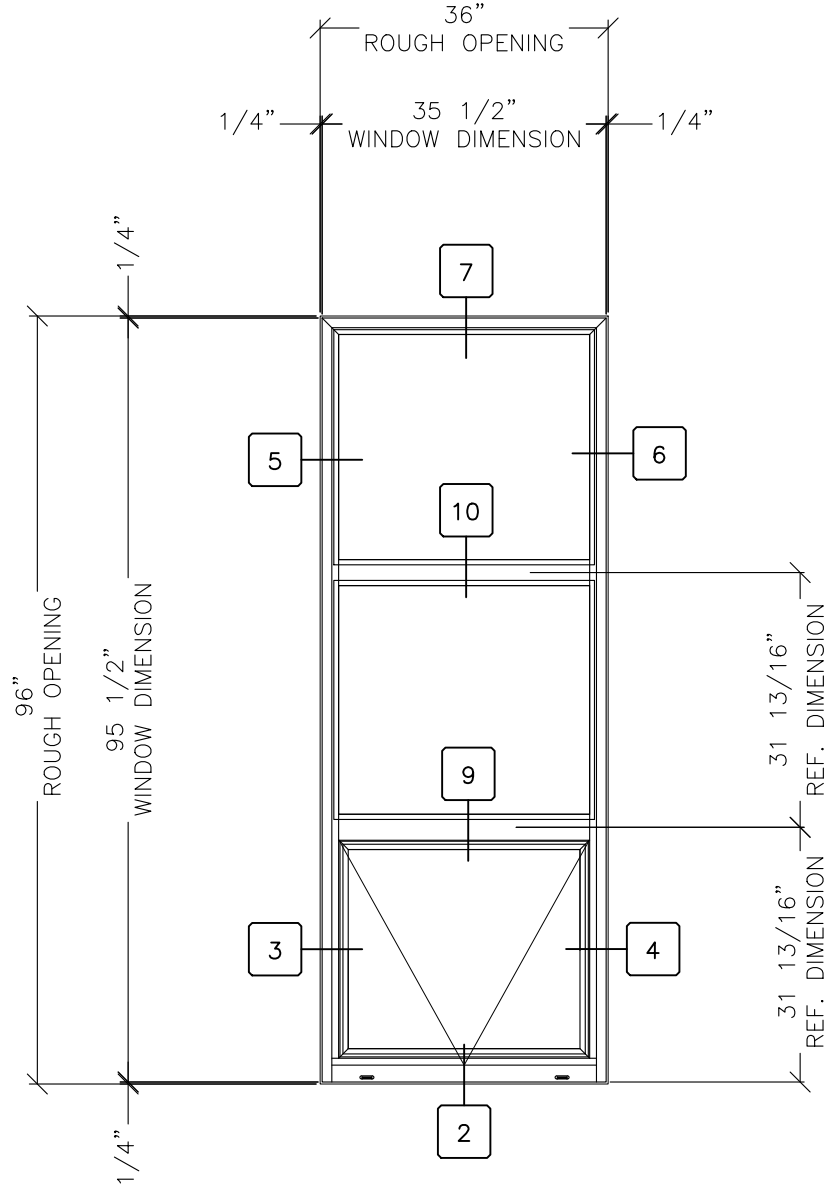

FIXED / PROJECT IN
WITH TRUE MUNTIN

Let's Shine.

800.737.2800 • fax 417.862.1232 • BoydAluminum.com

©2016 Boyd Aluminum Manufacturing. The Boyd sunburst and logotype are trademarks of Boyd Aluminum Manufacturing. All rights reserved. Due to continued product research, specifications are subject to change without notice.

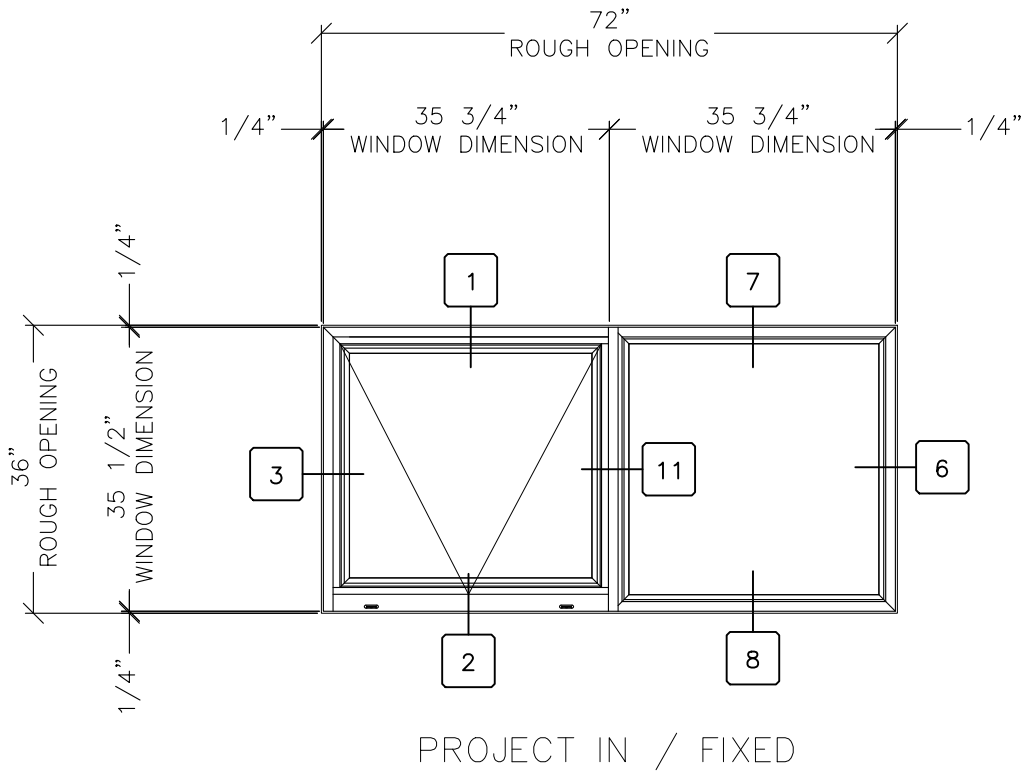

Let's Shine.

800.737.2800 • fax 417.862.1232 • BoydAluminum.com

©2016 Boyd Aluminum Manufacturing. The Boyd sunburst and logotype are trademarks of Boyd Aluminum Manufacturing.
All rights reserved. Due to continued product research, specifications are subject to change without notice.

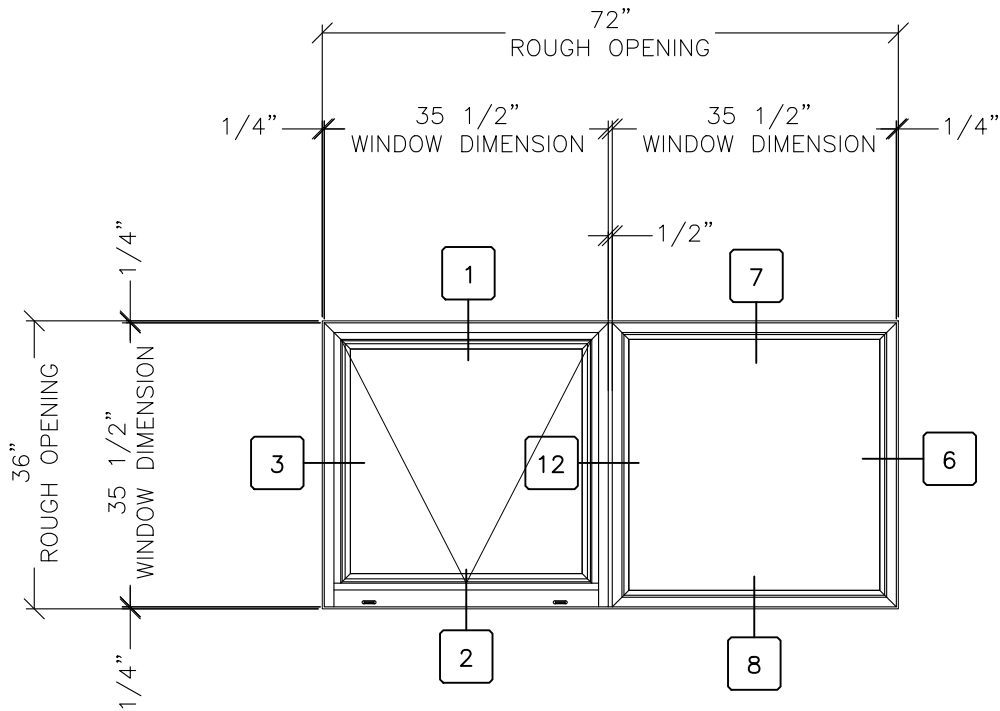

PROJECT IN /FIXED
522 MULLION

Let's Shine.

800.737.2800 • fax 417.862.1232 • BoydAluminum.com

©2016 Boyd Aluminum Manufacturing. The Boyd sunburst and logotype are trademarks of Boyd Aluminum Manufacturing. All rights reserved. Due to continued product research, specifications are subject to change without notice.

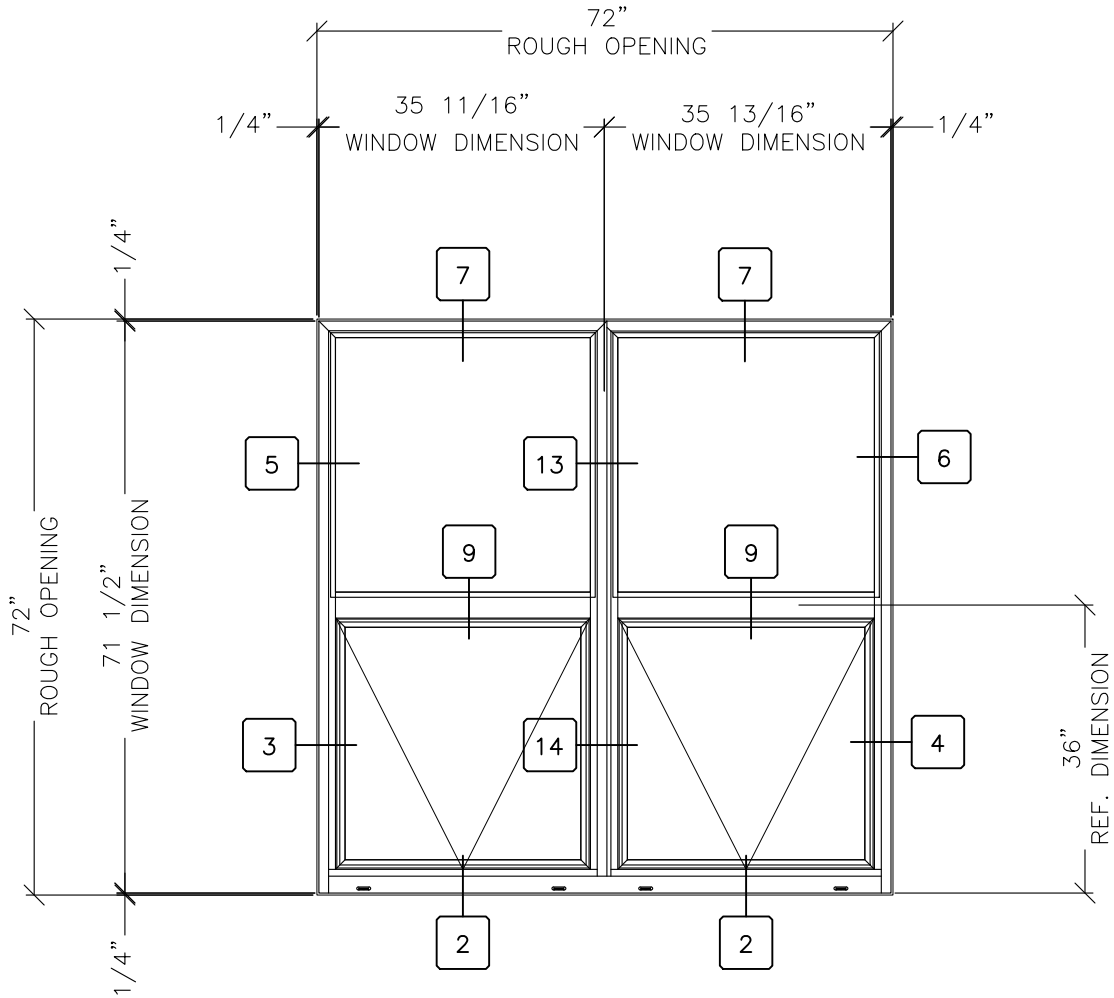

FIXED / PROJECT OUT – FIXED / PROJECT OUT
WITH SELF MULLION

Let's Shine.

800.737.2800 • fax 417.862.1232 • BoydAluminum.com

©2016 Boyd Aluminum Manufacturing. The Boyd sunburst and logotype are trademarks of Boyd Aluminum Manufacturing.
All rights reserved. Due to continued product research, specifications are subject to change without notice.

E6
040116

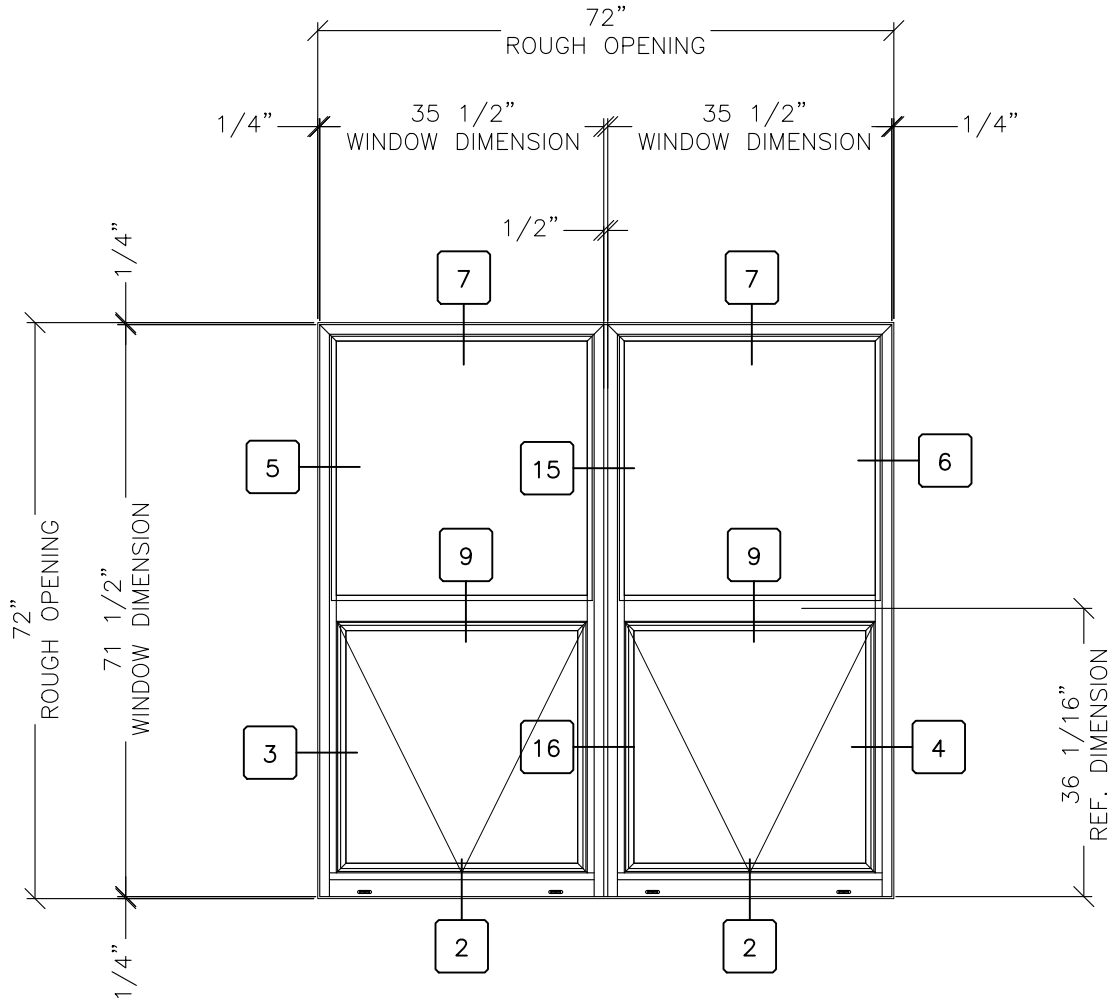

FIXED / PROJECT OUT – FIXED / PROJECT OUT
522 MULLION

Let's Shine.

800.737.2800 • fax 417.862.1232 • BoydAluminum.com

©2016 Boyd Aluminum Manufacturing. The Boyd sunburst and logotype are trademarks of Boyd Aluminum Manufacturing.
All rights reserved. Due to continued product research, specifications are subject to change without notice.

E7
040116

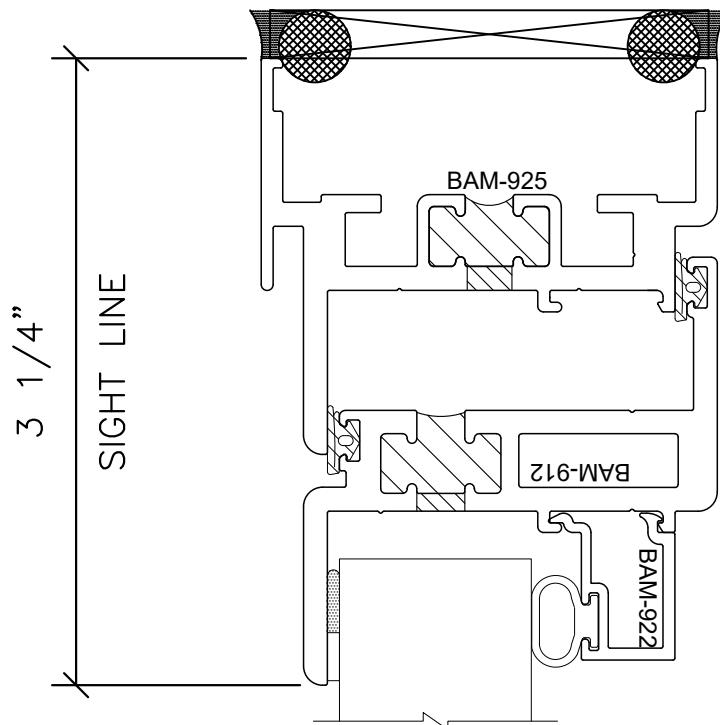

Let's Shine.

800.737.2800 • fax 417.862.1232 • BoydAluminum.com©2016 Boyd Aluminum Manufacturing. The Boyd sunburst and logotype are trademarks of Boyd Aluminum Manufacturing.
All rights reserved. Due to continued product research, specifications are subject to change without notice.**D1**
040116

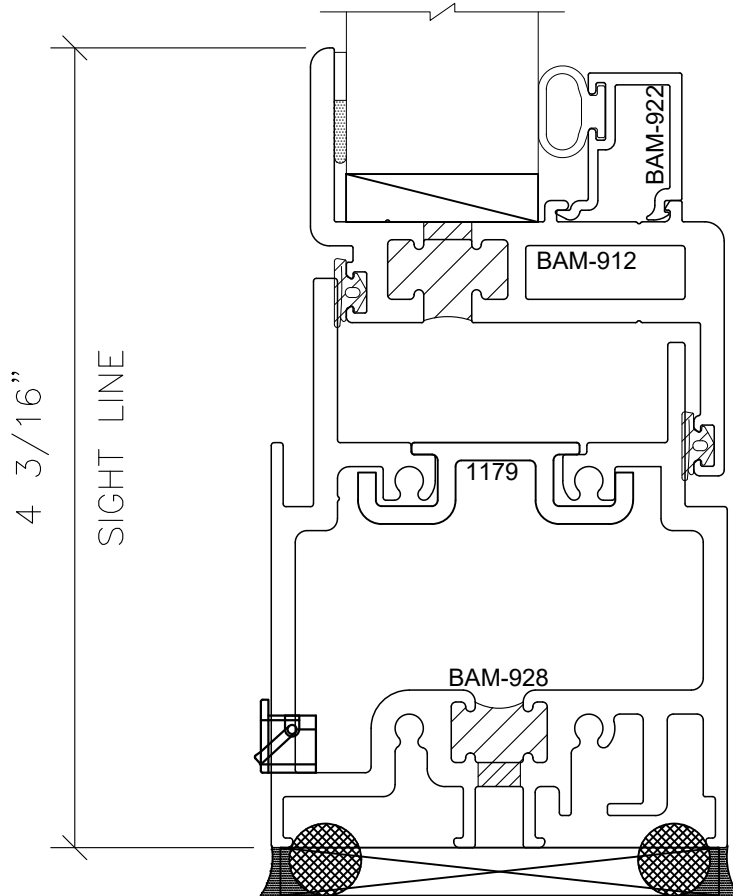

Let's Shine.

800.737.2800 • fax 417.862.1232 • BoydAluminum.com©2016 Boyd Aluminum Manufacturing. The Boyd sunburst and logotype are trademarks of Boyd Aluminum Manufacturing.
All rights reserved. Due to continued product research, specifications are subject to change without notice.**D2**
040116

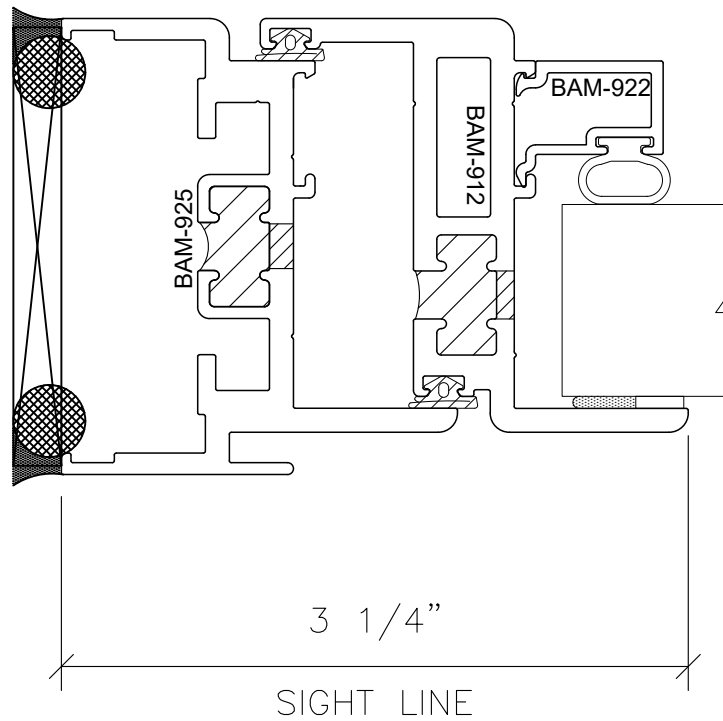

Let's Shine.

800.737.2800 • fax 417.862.1232 • BoydAluminum.com

©2016 Boyd Aluminum Manufacturing. The Boyd sunburst and logotype are trademarks of Boyd Aluminum Manufacturing.
All rights reserved. Due to continued product research, specifications are subject to change without notice.

D3
040116

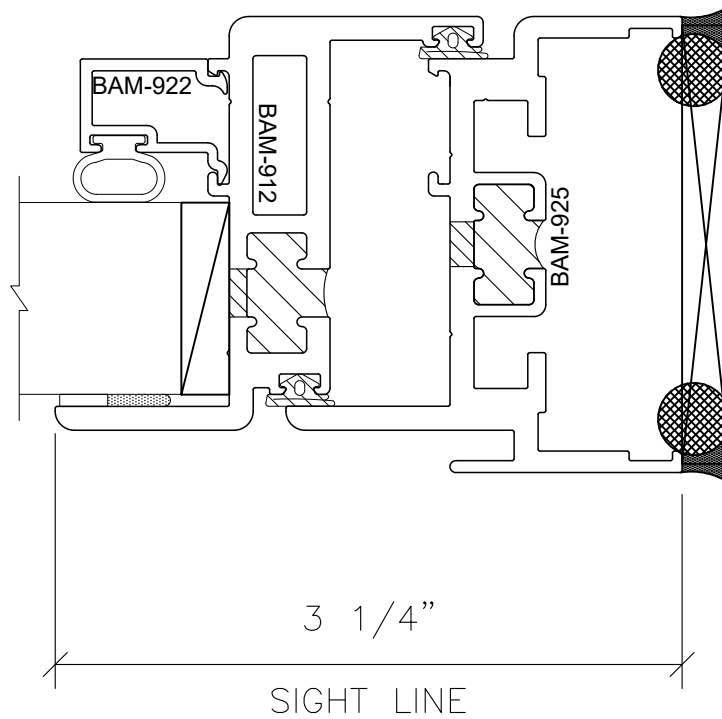

Let's Shine.

800.737.2800 • fax 417.862.1232 • BoydAluminum.com

©2016 Boyd Aluminum Manufacturing. The Boyd sunburst and logotype are trademarks of Boyd Aluminum Manufacturing.
All rights reserved. Due to continued product research, specifications are subject to change without notice.

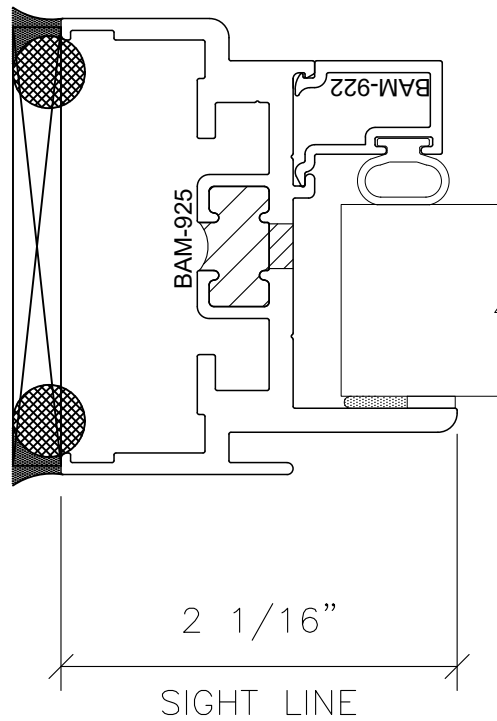

Let's Shine.

800.737.2800 • fax 417.862.1232 • BoydAluminum.com

©2016 Boyd Aluminum Manufacturing. The Boyd sunburst and logotype are trademarks of Boyd Aluminum Manufacturing.
All rights reserved. Due to continued product research, specifications are subject to change without notice.

D5
040116

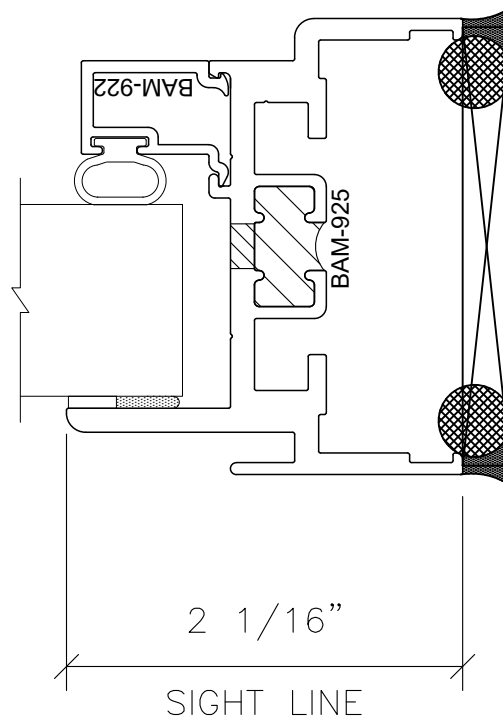

Let's Shine.

800.737.2800 • fax 417.862.1232 • BoydAluminum.com

©2016 Boyd Aluminum Manufacturing. The Boyd sunburst and logotype are trademarks of Boyd Aluminum Manufacturing.
All rights reserved. Due to continued product research, specifications are subject to change without notice.

D6
040116

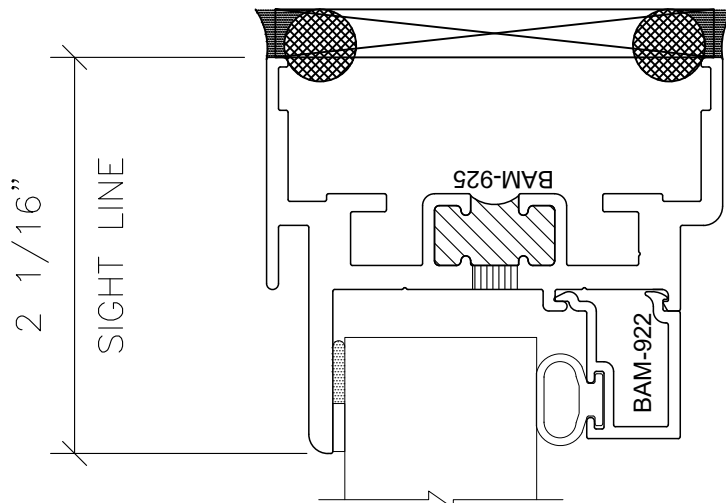

Let's Shine.

800.737.2800 • fax 417.862.1232 • BoydAluminum.com

©2016 Boyd Aluminum Manufacturing. The Boyd sunburst and logotype are trademarks of Boyd Aluminum Manufacturing.
All rights reserved. Due to continued product research, specifications are subject to change without notice.

D7
040116

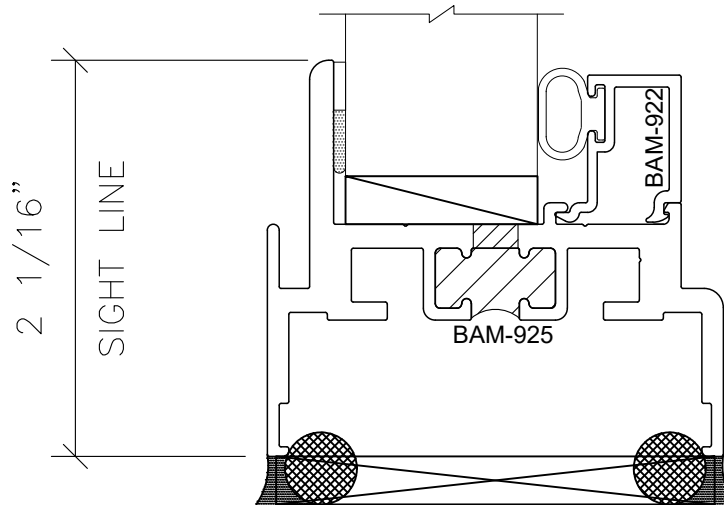

Let's Shine.

800.737.2800 • fax 417.862.1232 • BoydAluminum.com

©2016 Boyd Aluminum Manufacturing. The Boyd sunburst and logotype are trademarks of Boyd Aluminum Manufacturing.
All rights reserved. Due to continued product research, specifications are subject to change without notice.

D8
040116

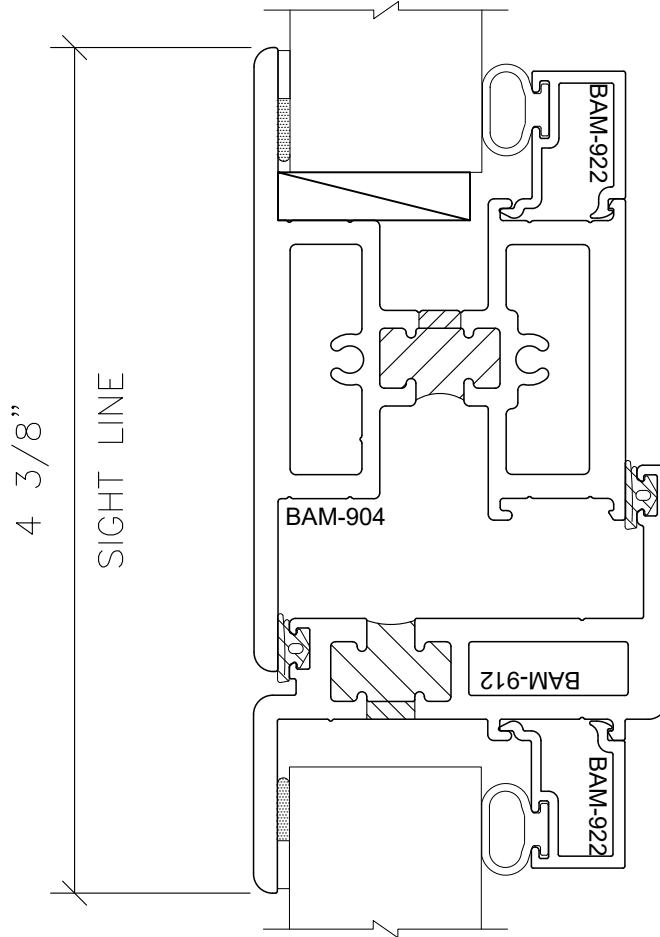

Let's Shine.

800.737.2800 • fax 417.862.1232 • BoydAluminum.com

©2016 Boyd Aluminum Manufacturing. The Boyd sunburst and logotype are trademarks of Boyd Aluminum Manufacturing.
All rights reserved. Due to continued product research, specifications are subject to change without notice.

D9
040116

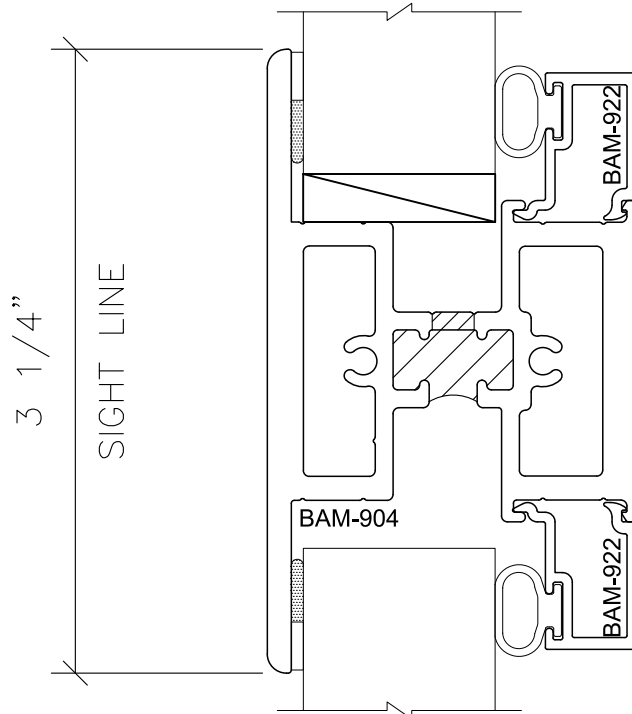

Let's Shine.

800.737.2800 • fax 417.862.1232 • BoydAluminum.com

©2016 Boyd Aluminum Manufacturing. The Boyd sunburst and logotype are trademarks of Boyd Aluminum Manufacturing.
All rights reserved. Due to continued product research, specifications are subject to change without notice.

D10
040116

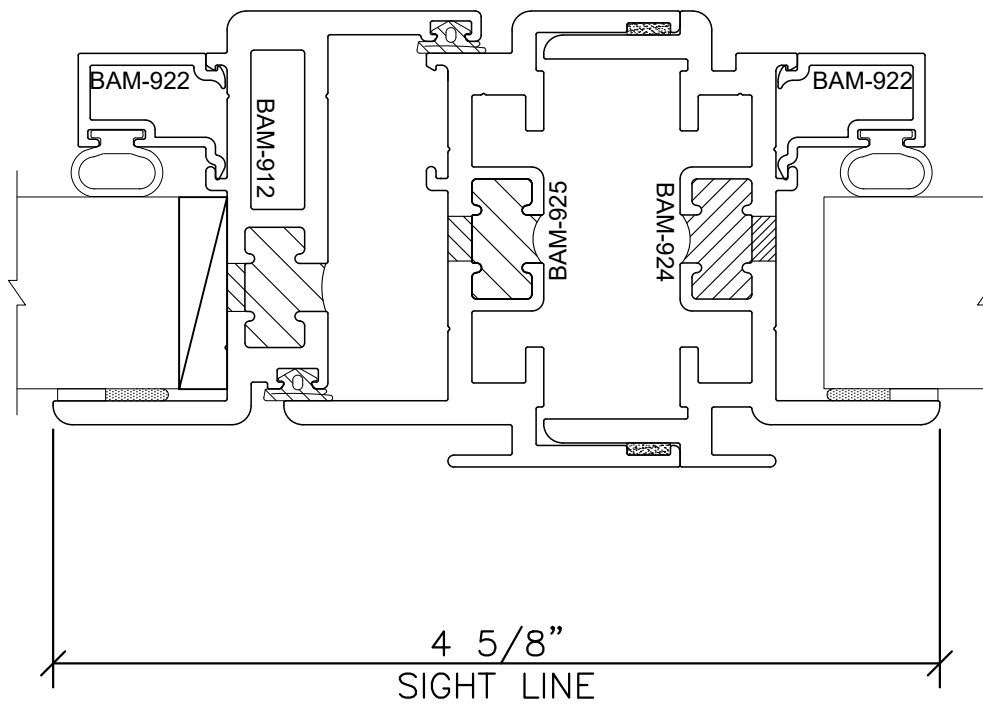

Let's Shine.

800.737.2800 • fax 417.862.1232 • BoydAluminum.com©2016 Boyd Aluminum Manufacturing. The Boyd sunburst and logotype are trademarks of Boyd Aluminum Manufacturing.
All rights reserved. Due to continued product research, specifications are subject to change without notice.D11
040116

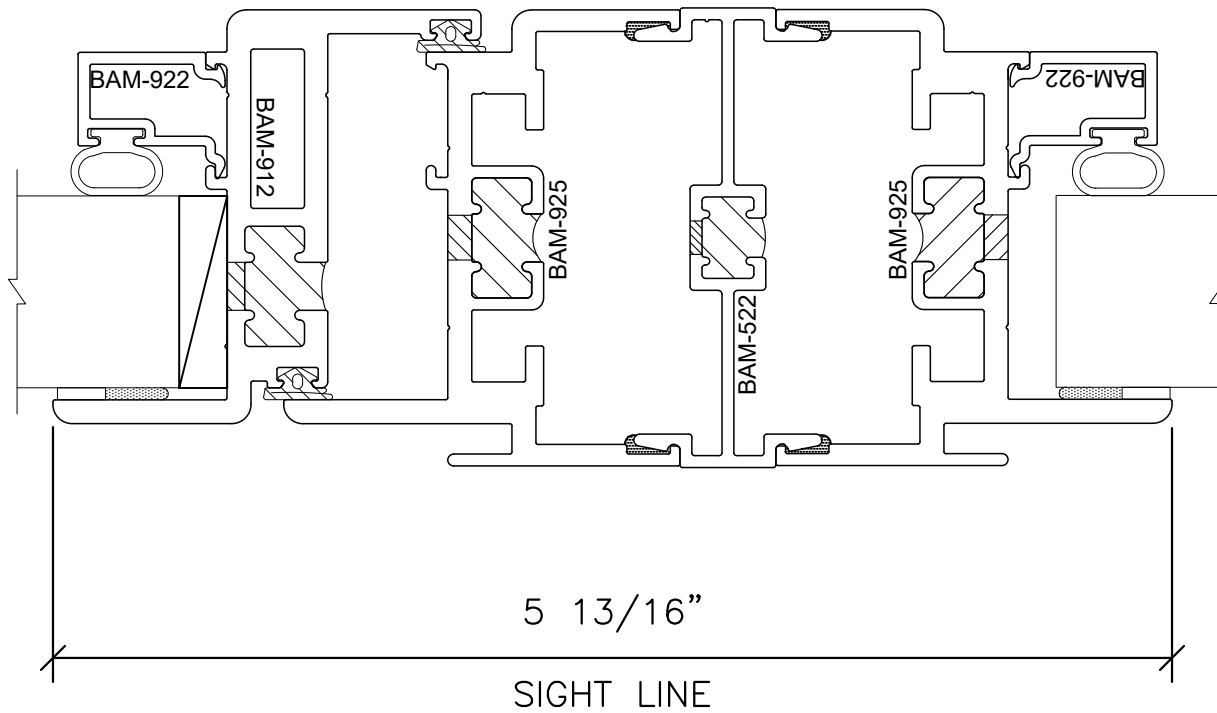

Let's Shine.

800.737.2800 • fax 417.862.1232 • BoydAluminum.com©2016 Boyd Aluminum Manufacturing. The Boyd sunburst and logotype are trademarks of Boyd Aluminum Manufacturing.
All rights reserved. Due to continued product research, specifications are subject to change without notice.**D12**
040116

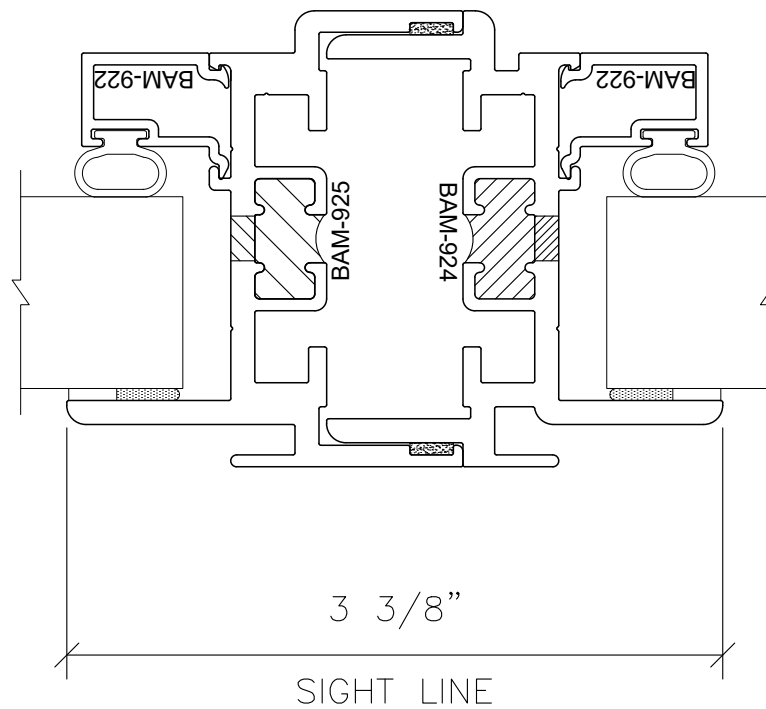

Let's Shine.

800.737.2800 • fax 417.862.1232 • BoydAluminum.com

©2016 Boyd Aluminum Manufacturing. The Boyd sunburst and logotype are trademarks of Boyd Aluminum Manufacturing.
All rights reserved. Due to continued product research, specifications are subject to change without notice.

D13
040116

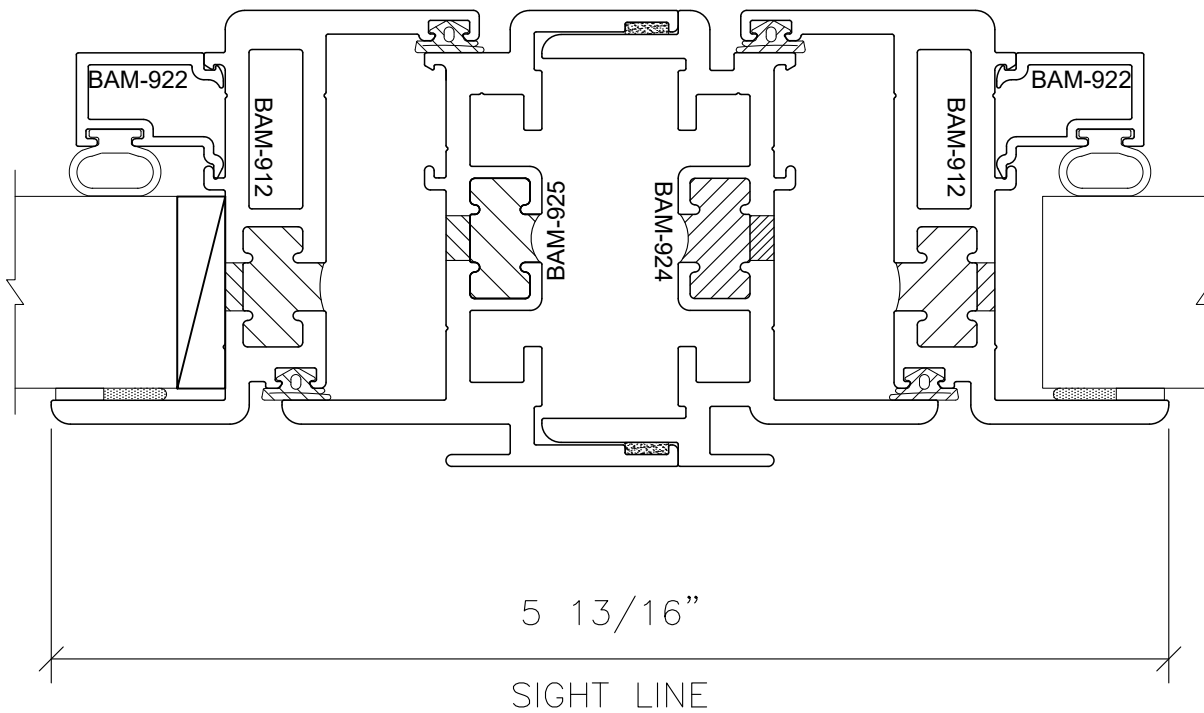

Let's Shine.

800.737.2800 • fax 417.862.1232 • BoydAluminum.com

©2016 Boyd Aluminum Manufacturing. The Boyd sunburst and logotype are trademarks of Boyd Aluminum Manufacturing.
All rights reserved. Due to continued product research, specifications are subject to change without notice.

D14
040116

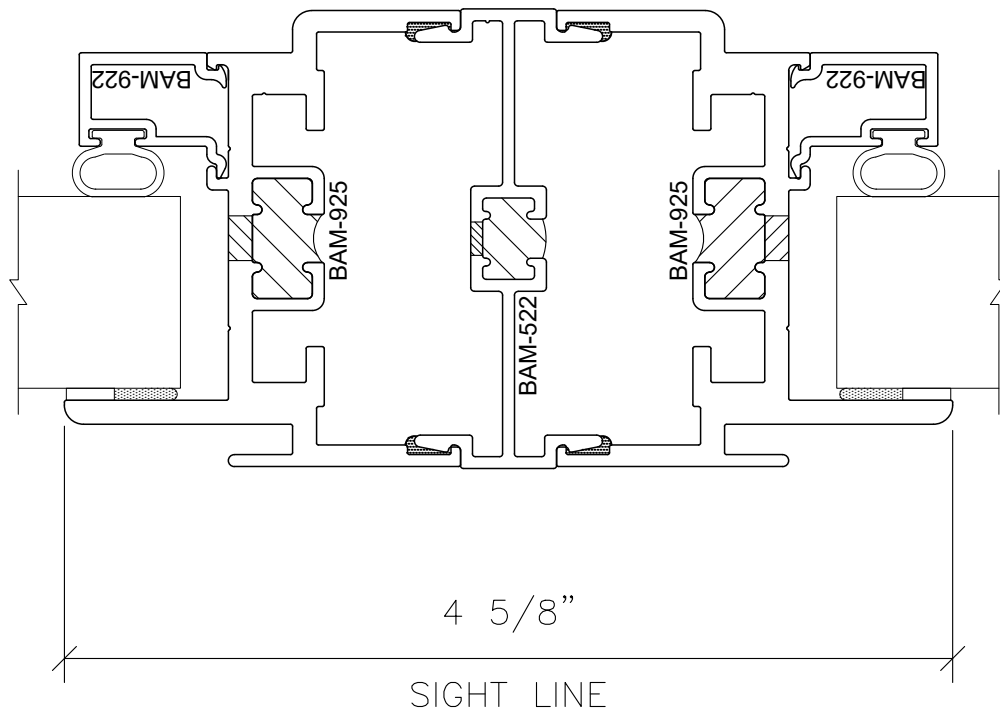

Let's Shine.

800.737.2800 • fax 417.862.1232 • BoydAluminum.com

©2016 Boyd Aluminum Manufacturing. The Boyd sunburst and logotype are trademarks of Boyd Aluminum Manufacturing.
All rights reserved. Due to continued product research, specifications are subject to change without notice.

D15
040116

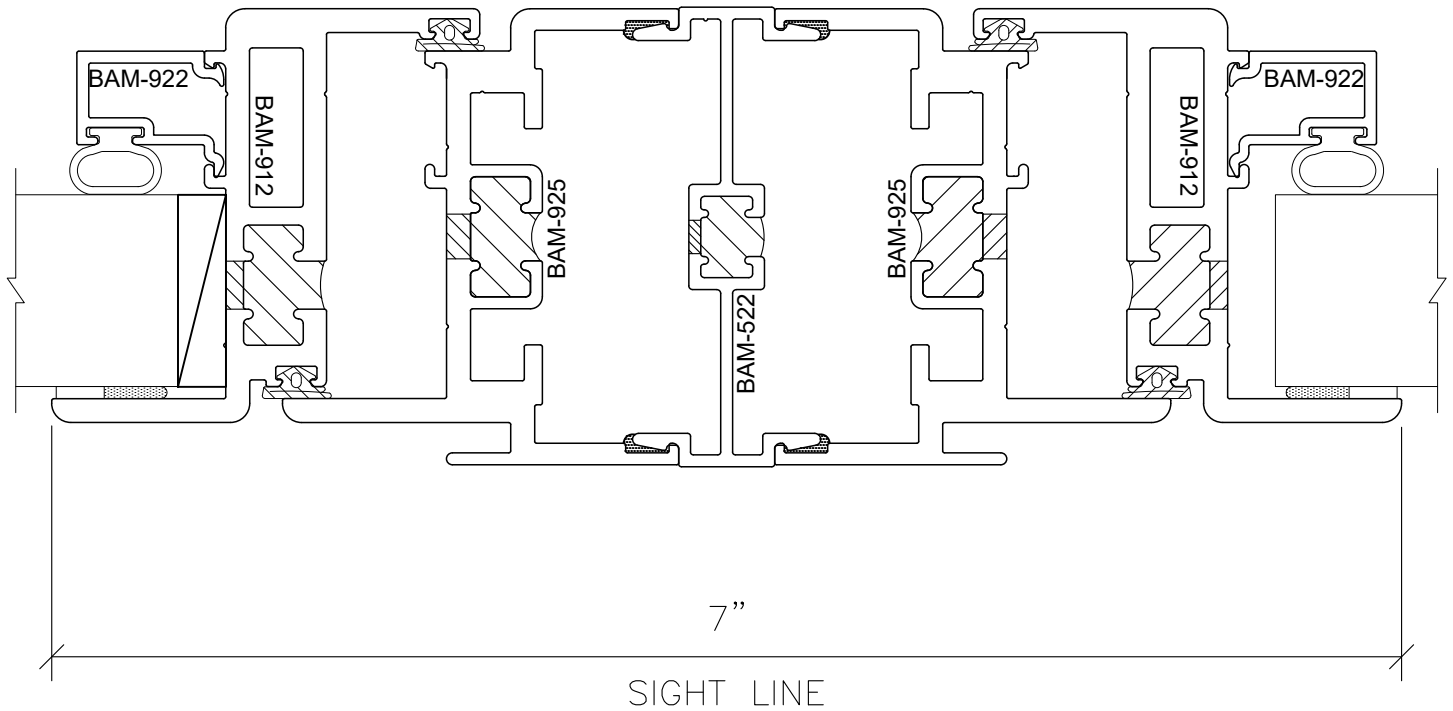

Let's Shine.

800.737.2800 • fax 417.862.1232 • BoydAluminum.com©2016 Boyd Aluminum Manufacturing. The Boyd sunburst and logotype are trademarks of Boyd Aluminum Manufacturing.
All rights reserved. Due to continued product research, specifications are subject to change without notice.**D16**
040116

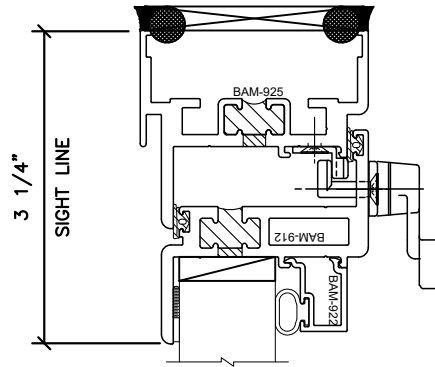

CAM LATCH

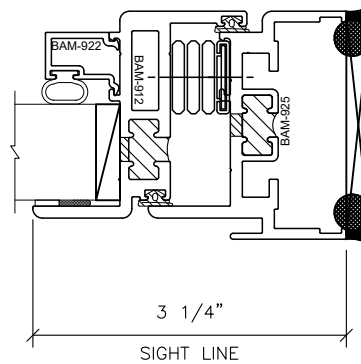

4-BAR ARM

Let's Shine.

800.737.2800 • fax 417.862.1232 • BoydAluminum.com

©2016 Boyd Aluminum Manufacturing. The Boyd sunburst and logotype are trademarks of Boyd Aluminum Manufacturing.
All rights reserved. Due to continued product research, specifications are subject to change without notice.

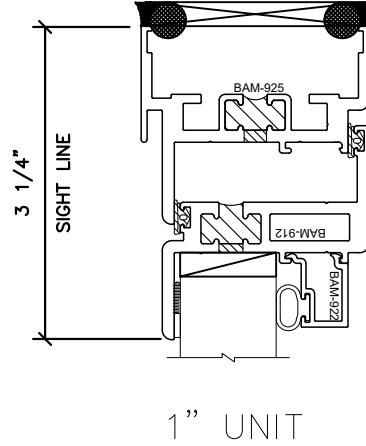
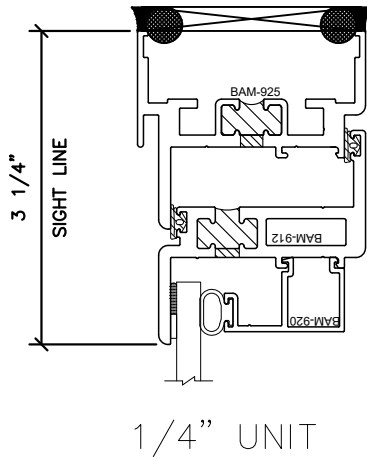

GLAZING

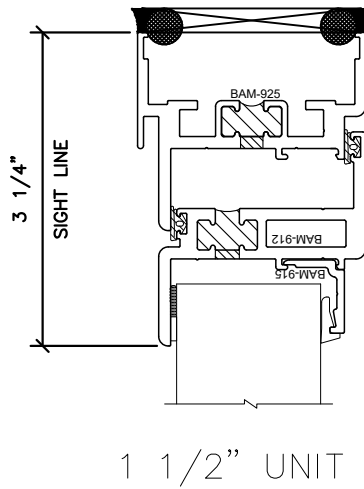

Let's Shine.